

## Product Information

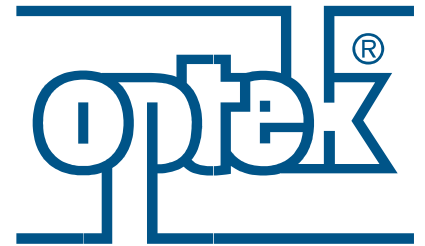

inline control

# X56 Series Photometric Detectors



english  
deutsch  
español  
portuguese  
中文  
français



For over 30 years, optek has focused on measuring process liquids through their interaction with light in facilities all over the world. Although global, optek remains a family owned company with a team of more than 100 qualified, customer-driven professionals.

Our confidence is born from experience. With the expertise of more than 30,000 installations worldwide, our value to the customer resides in providing a superior product that pays back. High quality materials withstand the toughest process conditions including aggressive media, high temperature, and

high pressure applications. Cleanability is ensured using high quality wetted materials, superior design, as well as sapphire optical windows.

As a global partner to various industries, optek offers the most advanced technologies including superior signal amplification, inline calibration support, PROFIBUS® PA, FOUNDATION™ Fieldbus and multilingual user interfaces for easy onsite operations.

Our support ensures long term satisfaction with programs such as “Speed-Parts” and “SwapRepair” to provide our

customers sustainable operations and minimized downtime at the lowest cost of ownership.

Conformity to international (ISO 9001), industry-specific (FM/ATEX approval) or company standards is easily achieved with optek. Wherever process composition is controlled, the name optek has become synonymous with world-class products and support.

**Optimize your process  
with optek inline control.**



## Content

156/556 – converters	03
156/556 - technical data	05
Turbidity sensor - TF56-N	06
Technical data - TF56-N	07
VIS/NIR absorption sensor AF56	08
Technical data - AF56	09
VIS/NIR absorption probe sensor AS56	10
Technical data - AS56	11
optek – worldwide contact	12

**See our various product and application brochures for further details**



## Converters 156 and 556

The 156 and 556 converter provide continuous inline, real-time measurement and control of concentrations, color changes or turbidity in a variety of industrial processes.

With four fixed measuring ranges and one variable measuring range, the converters can be set to match your specific process parameters.

The 3-digit LED indicator displays the percentage of the selected measuring range. Two independent set points and one mA output are provided for alarms and real-time process monitoring when wired to the plant's process control system. An additional failsafe relay output is built in for remote sensing of lamp or power failure.

Combined with a precision sensor, the converters are cost-effective measuring systems that provide reliable measurements throughout your process.

Converter	556	156
Turbidity sensors	TF56-N	AF56-N AS56-N
Color sensors	n/a	AF56-F AS56-F
Measuring principle	dual channel scattering of light (11°)	single channel absorption of light
Measuring ranges	TF56-N: 0 - 25 to 500 ppm (DE) 0 - 10 to 200 FTU 0 - 2.5 to 50 EBC	AF56-N: 0 - 0.5 to 4 CU AS56-N: 0 - 0.5 to 4 CU AF56-F: 0 - 0.5 to 2 CU AS56-F: 0 - 0.5 to 1.5 CU

## 04 | 156/556 - Converters

- Inline real-time process monitoring
- 3-digit LED display
- 0/4-20 mA-output
- 2 independent alarm setpoints
- Reliable cost effective measurements
- Compact dimensions

Back

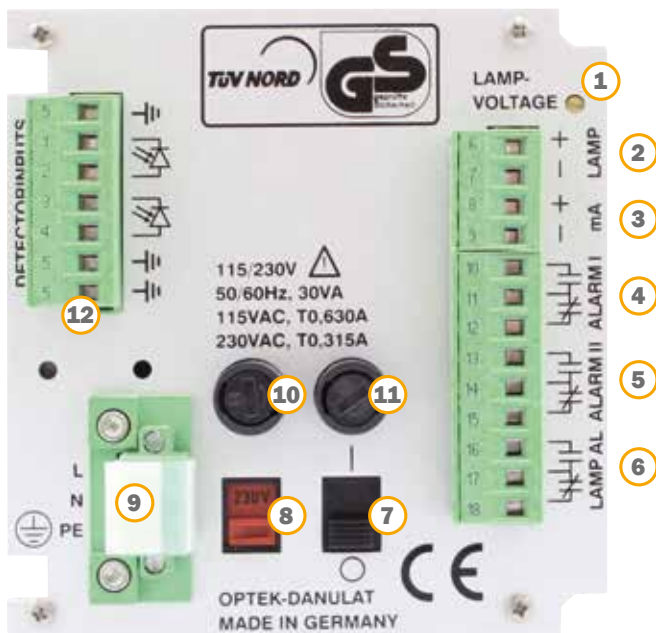

1. Potentiometer for lamp voltage
2. Lamp output (only for optek sensors)
3. mA output (4-20mA)
4. Relay output 1
5. Relay output 2
6. Relay output 3
7. Power switch
8. Selector switch for voltage
9. Power supply (fixed)
10. Fuse 1
11. Fuse 2
12. Detector input (only for optek sensors)

Front

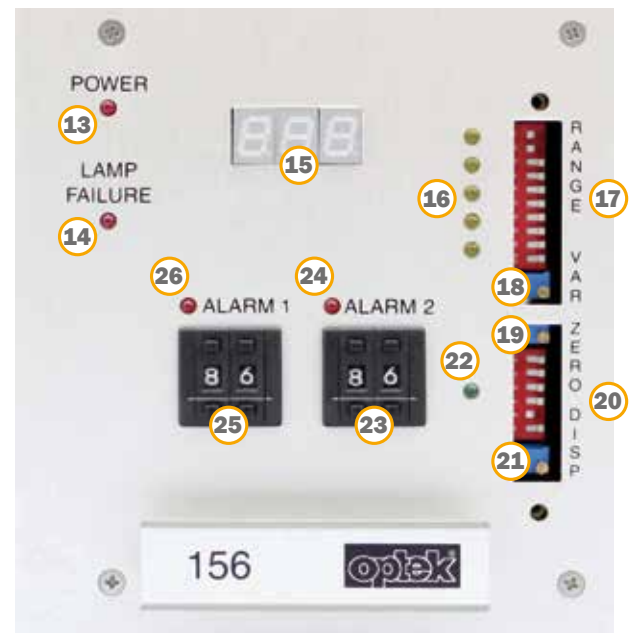

13. LED (red), power indication
14. LED (red), lamp failure indication
15. Digital read-out, LED display, 3 digits
16. 5 LEDs (yellow), indication of set measuring range
17. DIP switch (RANGE1-10) for measuring range setting
18. Potentiometer (VAR) for setting the variable measuring range
19. Potentiometer (ZERO) zero point setting
20. DIP switch (DISP 5-6) for setting digital read-out 1
21. Potentiometer for setting digital read-out 2
22. LED (green), zero point indication
23. Encoding button for setting alarm 2
24. LED (red), switch indicator for alarm 2
25. Encoding button for setting alarm 1
26. LED (red), switch indicator for alarm 1

Technical Data	156 Converter	556 Converter
<b>Housing</b>	19"-version for mounting in control cabinets 3 U / 21 HP - dimensions: W 106.3 mm (4.19 in.) H 128.4 mm (5.06 in.) D 208 mm (8.19 in.) - material: aluminium / diverse plastics - protection: front IP40 / rear IP20 (mains supply secured against accidental touching)	
<b>Display</b>	1 digital display, 3 digits, LED, height 7 mm	
<b>Operation</b>	dip switches, potentiometer, coding switch	
<b>LED</b>	1 LED (red): power on 1 LED (green): zero 5 LED (yellow): measuring ranges 2 LED (red): alarm I and II 1 LED (red): lamp or system failure	
<b>Sensor-inputs</b>	1 for optek photometric sensor AF56 or AS56	1 for optek photometric sensor TF56
<b>Sensor lamp-outputs</b>	1 lamp supply for optek photometric sensor 4.8 -7.0V DC	
<b>mA-outputs</b>	1 x 4 - 20 mA (functionally galvanically isolated) - accuracy: < 1 % - load: < 500 Ohm	
<b>Relay-outputs</b>	2 independently adjustable SPDT contacts 0 - 250 V AC, 0 - 300 V DC, 0 - 8 A (refer to load limit curve relay outputs in the manual) - for alarm I and II	
<b>Failsafe-output</b>	1 SPDT contact to alarm in case of lamp or system failure (active) 0 - 250 V AC, 0 - 300 V DC, 0 - 8 A (refer to load limit curve relay outputs in the manual)	
<b>Cable lengths (sensor)</b>	2, 3, 5, 10, 15, 20, 30 ... 100 m (7, 10, 16, 33, 49, 66, 98 ...328 ft) sensor AS56: max 50 m	
<b>Power supply (fixed)</b>	115 / 230 V AC, selectable (93.5 - 132 / 187 - 264 V AC, 47 - 64 Hz) or 24 V AC / DC (AC: 20.4 - 26.4 V AC, 47 - 64 Hz; DC: 20.4 - 28.8 V DC) - power consumption: < 30 VA	
<b>Ambient conditions</b>	temperature during operation (no direct sunlight): - converter: 0 - 50 °C (32 - 122 °F) - with optional stainless steel housing S19-42 (IP65): 0 - 40 °C (32 - 104 °F) - with optional plastic housing B19-42 (IP66): 0 - 35 °C (32 - 95 °F) - with optional plastic housing B19-21 (IP66): 0 - 35 °C (32 - 95 °F) temperature during transport (no direct sunlight): -20 - 70 °C ( -4 - 158 °F)	

Data given are subject to changes without prior notice.

## 156/556 - Accessories:

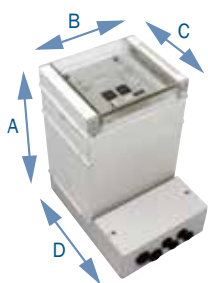

### B19-21

Wall mount housing (IP66)  
Material: Plastic (ABS)  
A: 287 mm (11.3 in.)  
B: 202 mm ( 8.2 in.)  
C: 147 mm ( 5.8 in.)  
D: 237 mm ( 9.4 in.)

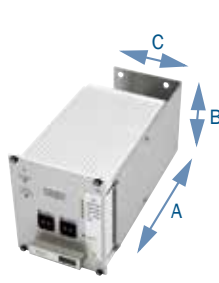

### W19

Mounting assembly for wall mounting  
Material: Stainless steel  
A: 200 mm (7.8 in.)  
B: 100 mm (3.9 in.)  
C: 90 mm (3.5 in.)

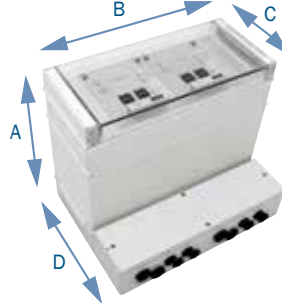

### B19-42

Wall mount housing (IP66)  
Material: Plastic (ABS)  
A: 287 mm (11.3 in.)  
B: 353 mm (13.9 in.)  
C: 147 mm ( 5.8 in.)  
D: 237 mm ( 9.4 in.)

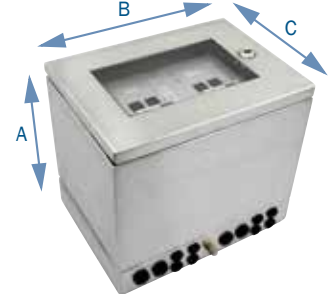

### S19-42

Wall mount housing (IP65)  
Material: Stainless steel 1.4301/SS304  
A: 301 mm (11.9 in.)  
B: 340 mm (13.4 in.)  
C: 237 mm ( 9.4 in.)

## 06 | Turbidity Sensor TF56-N

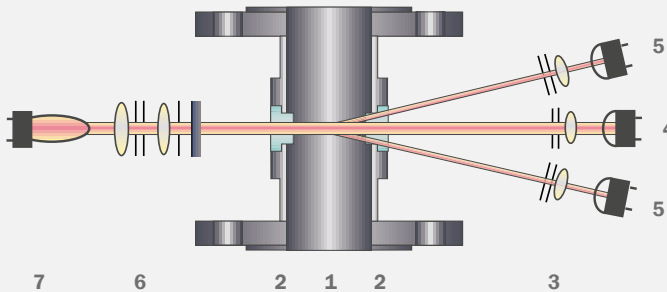

### Model TF56-N

Dual Channel  
Scattered Light (11°)

- 1 Sensor body
- 2 Windows
- 3 Focusing optics
- 4 Detector 0° (Abs.)
- 5 Four 11° detectors
- 6 Optics module
- 7 Lamp module

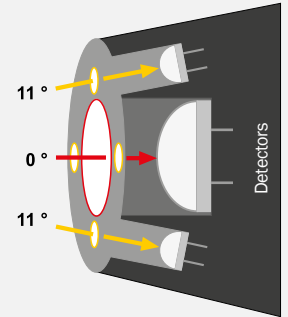

Model TF56-N is a precision turbidity sensor for use in various industries. The sensor is designed for inline operation and provides accurate concentration measurements with remarkable repeatability, linearity and resolution.

Modular construction of the sensor offers maximum flexibility in adapting to various process needs. Options include electro-polished sensor bodies, chemical resistant materials, (sapphire windows, titanium, Hastelloy, etc.) and high temperature or high pressure versions.

### TF56-N (Scattered Light / Turbidity)

Light scattered from particles (trace suspended solids, immiscible liquids or gas bubbles) in the medium is detected by four hermetically sealed silicon photodiodes at an angle of 11°. At the same time, the unscattered light is detected by a reference photodiode.

This unique dual channel design compensates for disturbances of the carrier medium. The sensor can be calibrated in ppm (DE), EBC or FTU and measures extremely low particle sizes and concentrations.

Special optical windows are made from a single crystal sapphire, providing superior resistance to all abrasive and corrosive media. With the appropriate choice of sensor bodies and a broad variety of line sizes available, the TF56 can be easily adapted to the process.

#### Typical Applications:

- Filter control
- Heat exchanger leak detection
- Lauter tun in brewery
- Liquid sugar clarity

**See our various product and application brochures for further details**



optek TF56-N  
Scattered Light Dual Channel  
Turbidity Sensor

Technical Data		TF56-N (Turbidity)
<b>Measurement</b>		
<b>Measurement principle</b>	2- Channel Scattering of light (11°)	
<b>Measurement wavelength</b>	730 nm - 970 nm	
<b>Detectors</b>	1 silicon photodiode (hermetically sealed) (Abs.) 4 silicon photodiodes (hermetically sealed) (11°)	
<b>Measuring range</b>	any measuring range between 0 - 25 to 500 ppm (DE) 0 - 10 to 200 FTU 0 - 2.5 to 50 EBC	
<b>Optical path length</b>	40 mm standard (50 - 60 mm with reduced accuracy)	
<b>Calibration</b>	basic calibration 11°: in ppm (DE) / FTU / EBC	
<b>Light source</b>	special incandescent tungsten lamp 5.0 V DC, 970 mA typical life span: 3 to 5 years (25,000 to 40,000 hours)	
<b>Resolution</b>	< ± 0.5 % of respective measuring range	
<b>Repeatability</b>	< ± 1 % of respective measuring range	
<b>Linearity</b>	< ± 2 % of respective measuring range (specific to application)	
<b>Protection</b>	all optical parts have an IP rating of IP65 or higher	
<b>Sensor body</b>		
<b>Material</b>	Stainless steel 1.4435 (SS 316L), 1.4539, 1.4571 (SS 316Ti), 1.4462, Titanium 3.7035 (Grade 2), Hastelloy 2.4602 (C22), Plastic TFM4215, PVC, ... others on request	
<b>Line size</b>	1/8 in. to 6 in. (DN 6 to DN 150), ... others on request	
<b>Process connection</b>	Flanges (ASME, DIN, JIS), Clamps (TC, ISO, DIN), Female Threads (NPT, DIN), Sanitary Threads (DIN 11851), Tube Ends (DIN, ISO, OD), Varivent, ... others on request	
<b>Process pressure</b>	10 mbar to 100 bar (0.15 psi to 1450 psi) - higher on request depending on process connection, materials and design	
<b>Windows</b>	1-Pyrex®, 2-Sapphire, 3-Sapphire Biotech	
<b>Window gaskets</b>	Silicone (FDA), Viton® (FDA), EPDM (FDA / USP Class VI), Kalrez® 4079, ... others on request	
<b>Temperature ratings</b>		
<b>Process temperature</b>	permanent: 0 - 100 °C (32 - 212 °F) / peak 15 min/day: 0 - 120 °C (32 - 248 °F)	
<b>Process temperature OPTION HT</b>	permanent: -20 - 190 °C (-4 - 374 °F) / peak 15 min/day: -20 - 210 °C (-4 - 410 °F)	
<b>Ambient temperature</b>	operation: 0 - 40 °C (32 - 104 °F) operation: -20 - 40 °C (-4 - 104 °F) with option HT transport: -20 - 70 °C (-4 - 158 °F)	

Pressure and temperature ratings specified herein may be subject to limitations - see instruction manual. The appropriate choice of material for all wetted parts is the sole responsibility of the user. Data given are subject to changes without prior notice.

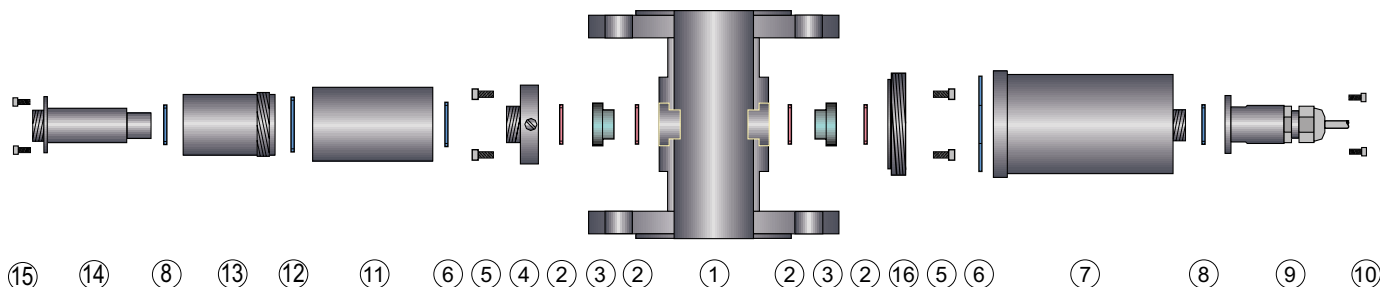

### Description TF56-N:

- |   |   |
|---|---|
| 1 Sensor body 1/8 in. to 6 in. (DN 6 to DN 150) | 9 SS-plug protection (1.4571 / 316 Ti)    |
| 2 O-ring (EPDM, Viton®, Kalrez® etc.)           | 10 4 Screws (M3 x 6)                      |
| 3 Window (Sapphire, Pyrex®)                     | 11 Optics module TF56                     |
| 4 Window ring M24 (1.4571 / 316 Ti)             | 12 O-ring 31,47 x 1,78 mm                 |
| 5 8 Screws with washer                          | 13 Optical housing OH06 (1.4571 / 316 Ti) |
| 6 O-ring (Viton®)                               | 14 Lamp module TF56                       |
| 7 Detector module TF56                          | 15 4 Screws (M3 x 6)                      |
| 8 O-ring (Viton®)                               | 16 Window ring M58 (1.4571 / 316 Ti)      |

# 08 | VIS/NIR Absorption Sensor AF56

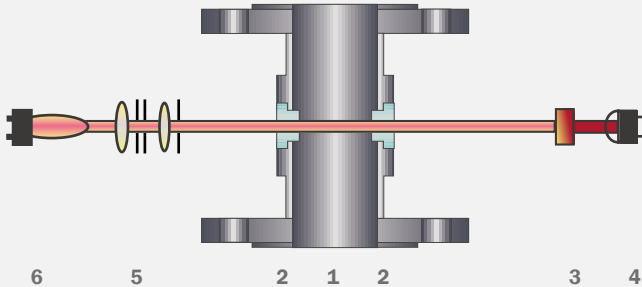

### Model AF56

Single Channel Absorption

- 1 Sensor body
- 2 Windows
- 3 Filter
- 4 Measurement detector
- 5 Optics module
- 6 Lamp module

Model AF56-N is a precision turbidity detector and the model AF56-F is a precision color detector for use in various industries. The sensors are designed for inline operation and provide accurate concentration measurements with remarkable repeatability, linearity and resolution.

Modular construction of the sensors offers maximum flexibility in adapting to various process needs. Options include electro-polished sensor bodies, chemical resistant materials (sapphire windows, titanium, Hastelloy, etc.) and high pressure versions.

A special tungsten lamp produces a constant light beam that passes through the process medium. The attenuation of the light intensity, caused by absorption and/or scattering by dissolved and undissolved substances, is detected by a sealed silicon photodiode.

### AF56-N (NIR-Absorption / Turbidity)

The AF56-N uses light from 730 - 970 nm (NIR) to measure solids concentration independent from color or color changes. Depending on the optical path length, measuring ranges from g/l to ppm are possible.

### AF56-F (VIS-Absorption/Color)

The AF56-F is used to measure color or color changes at a specific wavelength in the visible range (430 nm). A loss of light as a result of an increase in color depth is precisely detected.

### OPL

Special optical windows are made from a single crystal sapphire, providing superior resistance to all abrasive and corrosive media. With the appropriate choice of sensor bodies and windows in various lengths, the optimum OPL (optical path length = distance between the windows) can be achieved to meet the measurement requirements, i.e., low/high measuring ranges at highest resolution.

### Typical Applications:

- *Lauter tun in brewery (AF56-N)*
- *Milk/water phase separation (AF56-N)*
- *Beer/yeast phase separation (AF56-N)*
- *Beer/water phase separation (AF56-F)*
- *Outlet/inlet separator control (AF56-N)*

**See our various product and application brochures for further details**



optek AF56  
Single Channel VIS/NIR  
Absorption Sensor



optek AF56  
Single Channel VIS/NIR  
Absorption Sensor  
with Varivent Connection



Technical Data	AF56-N (Turbidity)	AF56-F (Color)
<b>Measurement</b>		
<b>Measurement principle</b>	1- Channel Absorption of light	
<b>Measurement wavelength</b>	730 nm - 970 nm	430 nm
<b>Detector</b>	1 silicon photodiode (hermetically sealed)	
<b>Measuring range</b>	any measuring range between 0 - 0.5 to 4 CU	any measuring range between 0 - 0.5 to 2 CU
<b>Optical path length</b>	1 - 200 mm	
<b>Calibration</b>	Abs.: CU (concentration units) application specific calibration	
<b>Light source</b>	special incandescent tungsten lamp 5.0 V DC, 970 mA typical life span: 3 to 5 years (25,000 to 40,000 hours)	
<b>Resolution</b>	< ± 0.5 % of respective measuring range	
<b>Repeatability</b>	< ± 1 % of respective measuring range	
<b>Linearity</b>	< ± 2 % of respective measuring range (specific to application)	
<b>Protection</b>	all optical parts have an IP rating of IP65 or higher	
<b>Sensor body</b>		
<b>Material</b>	Stainless steel 1.4435 (SS 316L), 1.4539, 1.4571 (SS 316Ti), 1.4462, Titanium 3.7035 (Grade 2), Hastelloy 2.4602 (C22), Plastic TFM4215, PVC, ... others on request	
<b>Line size</b>	1/8 in. to 6 in. (DN 6 to DN 150), ... others on request	
<b>Process connection</b>	Flanges (ASME, DIN, JIS), Clamps (TC, ISO, DIN), Female Threads (NPT, DIN), Sanitary Threads (DIN 11851), Tube Ends (DIN, ISO, OD), Varivent, ... others on request	
<b>Process pressure</b>	10 mbar to 100 bar (0.15 psi to 1450 psi) - higher on request depending on process connection, materials and design	
<b>Windows</b>	1-Pyrex®, 2-Sapphire, 3-Sapphire Biotech	
<b>Window gaskets</b>	Silicone (FDA), Viton® (FDA), EPDM (FDA / USP Class VI), Kalrez® 4079, ... others on request	
<b>Temperature ratings</b>		
<b>Process temperature</b>	permanent: 0 - 100 °C (32 - 212 °F) / peak 15 min/day: 0 - 120 °C (32 - 248 °F)	
<b>Process temperature OPTION SF</b>	permanent: 0 - 60 °C (32 - 140 °F) / peak 15 min/day: 0 - 80 °C (32 - 176 °F)	
<b>Ambient temperature</b>	operation: 0 - 40 °C (32 - 104 °F) transport: -20- 70 °C (-4 - 158 °F)	

Pressure and temperature ratings specified herein may be subject to limitations - see instruction manual.  
The appropriate choice of material for all wetted parts is the sole responsibility of the user.  
Data given are subject to changes without prior notice.



Windows available in different lengths for OPL (optical path length) adjustment.



# 10 | VIS/NIR Probe Sensor AS56

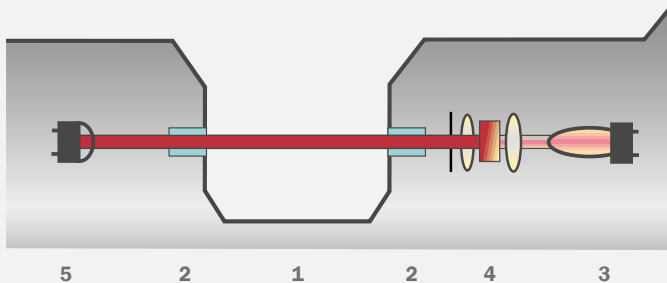

### Model AS56

Single Channel Absorption

- 1 OPL
- 2 Windows
- 3 Lamp module
- 4 Optics modules (incl. filter)
- 5 Detector module

No window gaskets used

Models AS56 are precision sensors measuring turbidity (AS56-N) or color (AS56-F) for use in various industries. The sensors are designed for inline operation and provide accurate concentration measurements with remarkable repeatability, linearity and resolution.

### AS56

The AS56, based on the same design as the AS16 has wetted parts made from electro-polished stainless steel and a seal-less window construction. It is typically used in food and beverage applications to allow cost-effective measurements (e.g., phase separation).

### NIR-Absorption (Turbidity) VIS-Absorption (Color)

A special tungsten lamp produces a constant light beam that passes through the process medium. The attenuation of the light intensity, caused by absorption and/or scattering by dissolved and undissolved substances, is detected by a sealed

silicon photodiode. AS56-N uses light from 730 - 970 nm to measure solids concentration independent from color or color changes (e.g., yeast concentration in beer during tank draining).

AS56-F uses a specific wavelength of 430 nm in the visible spectrum to measure color in liquids with little or no turbidity (e.g., beer in water during phase change).

### OPL

Special optical windows are made from a single crystal sapphire, providing superior resistance to all abrasive and corrosive media. optek superior manufacturing techniques allow mounting the windows without gaskets or glue for a lifetime without maintenance. The appropriate choice of the optimum OPL (optical path length = distance between the windows) supports all measurement requirements, i.e., low/high measuring ranges at highest resolution.

### Typical Applications:

- Milk/water phase separation (AS56-N)
- Beer/yeast phase separation (AS56-N)
- Beer/water phase separation (AS56-F)
- Inlet separator control (AS56-N)

See our various product and application brochures for further details



optek AS56 Single Channel Absorption Probe

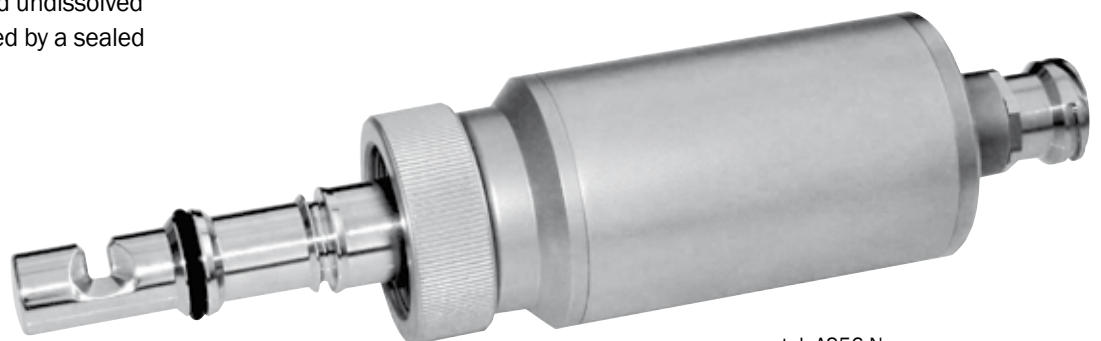

optek AS56-N  
Single Channel Absorption Probe

Technical Data	AS56-N (Turbidity)	AS56-F (Color)
<b>Measurement</b>		
<b>Measurement principle</b>	1-Channel Absorption of light	
<b>Detector</b>	1 silicon photodiode (hermetically sealed)	
<b>Measurement wavelength</b>	730 - 970 nm	430 nm
<b>Measuring range</b>	any measuring range between 0 - 0.5 to 4 CU	any measuring range between 0 - 0.5 to 1.5 CU
<b>Optical path length</b>	5 or 10 mm	
<b>Calibration</b>	CU (concentration units) application specific calibration	
<b>Light source</b>	special incandescent tungsten lamp 5.0 V DC, 450 mA typical life span: 3 to 5 years (25,000 to 40,000 hours)	
<b>Resolution</b>	< ± 0.5 % of respective measuring range	
<b>Repeatability</b>	< ± 1.0 % of respective measuring range	
<b>Linearity</b>	< ± 2 % of respective measuring range (specific to application)	
<b>Protection</b>	all optical parts have an IP rating of IP65 or higher	
<b>Process adaption</b>		
<b>Material</b>	wetted parts: stainless steel 1.4435 (SS 316 L) surface: electro-polished Ra < 0.8 µm housing: stainless steel 1.4571 (SS 316 Ti)	
<b>Port connection</b>	thread G1-1/4 in., ISO 228/1 for port AS25 (similar Ingold-port) diameter: 25 mm ( D= 25 H7) O-ring groove for 30 mm and for 60 mm port length	
<b>Port gasket</b>	O-ring 18,64 x 3,53 mm EPDM (FDA / USP Class VI)	
<b>Insertion depth</b>	35 mm (1.38 in.) + OPL at a port length of 60 mm (2.36 in.)	
<b>Process pressure</b>	10 mbar to 10 bar (0.15 psi to 145 psi)	
<b>Windows</b>	sapphire (seal-less)	
<b>Window gaskets</b>	n/a	
<b>Installation accessories</b>	weld-in ports, Varivent adapter (50.00), clamp adapter (1.5 and 2.0 in.)	
<b>Temperature ratings</b>		
<b>Process temperature</b>	permanent: 0 - 90 °C (32 - 194 °F) peak 60 min/day: 0 - 100 °C (32 - 212 °F)	
<b>Ambient temperature</b>	operation: 0 - 40 °C (32 - 104 °F) transport: -20 - 70 °C (-4 - 158 °F)	

Pressure and temperature ratings specified herein may be subject to limitations - see instruction manual.  
The appropriate choice of material for all wetted parts is the sole responsibility of the user.  
Data given are subject to changes without prior notice.

## AS56 Probe Accessories:



Varivent adapter



Weld-in port 15°



Weld-in port 0°



## Germany

optek-Danulat GmbH  
Emscherbruchallee 2  
45356 Essen / Germany  
Phone: +49 201 63409 0  
E-Mail: info@optek.de



## USA

optek-Danulat Inc.  
N118 W18748 Bunsen Drive  
Germantown WI 53022 / USA  
Phone: +1 262 437 3600  
Toll free call: +1 800 371 4288  
Fax: +1 262 437 3699  
E-Mail: info@optek.com



## Singapore

optek-Danulat Pte. Ltd.  
25 Int'l Business Park  
#02-09 German Centre  
Singapore 609916  
Phone: +65 6562 8292  
Fax: +65 6562 8293  
E-Mail: info@optek.com.sg



## China

optek-Danulat Shanghai Co., Ltd.  
Room 718 Building 1  
No.88 Keyuan Road  
Pudong Zhangjiang  
Shanghai, China 201203  
Phone: +86 21 2898 6326  
Fax: +86 21 2898 6325  
E-Mail: info@optek-danulat.com.cn

## 中国

优培德在线测量设备（上海）  
有限公司  
上海张江科苑路88  
号德国中心718  
室 邮编:201203  
电话:+86-21-28986326  
传真:+86-21-28986325  
E-Mail: info@optek-danulat.com.cn

Please visit our website for contact details of our local distributors in other countries.

[www.optek.com](http://www.optek.com)