

ENGINEERING  
YOUR SPRAY SOLUTION

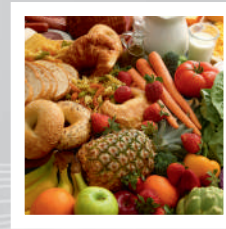

## Precision Spray Nozzles for Tank and Equipment Cleaning

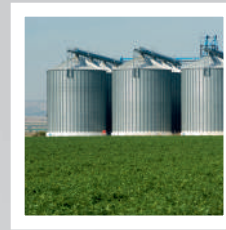

# Tank and Equipment Cleaning

# LECHLER NOZZLES FOR TANK AND EQUIPMENT CLEANING – ECONOMICAL, SAFE AND PROVEN OVER TIME

Lechler is a world leader in nozzle technology. For over 135 years, we have pioneered numerous groundbreaking developments in this field. Comprehensive nozzle engineering and an in-depth understanding of application-specific requirements help us to create products that offer outstanding performance and reliability.

## Optimized cleaning processes

Companies all over the world, in a wide range of industries, rely on Lechler tank and equipment cleaning nozzles for thorough cleaning of all kinds of tank sizes, machines and equipment.

## Your advantages

- None of the risks, restrictions and costs related to manual tank cleaning
- Modern nozzle technology cuts cleaning fluid consumption and reduces downtimes
- The cleaning process is trouble-free, repeatable and verifiable

## New products for practically any application

The Lechler tank and equipment cleaning nozzle range features innovative drive concepts, state-of-the-art nozzle design, as well as a large choice of sizes and materials. The scope of our portfolio is unique to the market and offers the perfect solution for every application.

## High cleaning performance at low pressure

Thanks to their sophisticated technology, Lechler tank and equipment cleaning nozzles already achieve high cleaning performance even at low pressures. This saves on high energy costs. The nozzles are driven and lubricated by the cleaning fluid and are therefore maintenance-free and reliable.

## Your experienced specialist – anywhere in the world

With subsidiaries in Hungary, the USA, England, India, China, France, Belgium, Sweden, Finland and Spain as well as qualified agents in over 40 countries, Lechler is represented all over the world. We will help you solve your cleaning problems — wherever you are.

## Industries

- Chemical industry
- Food and beverage industry
- Tank and equipment engineering
- Machine tool engineering
- Cosmetics industry
- Pharmaceutical industry
- Biotechnology
- Agricultural engineering



# THE ART OF MAKING THE RIGHT CHOICE



## Unique range of solutions

There is no one single perfect tank and equipment cleaning nozzle. That is because requirements differ greatly in each individual application. Over the course of the years, we have developed specialized nozzles for a wide variety of different purposes. Today we offer the world's largest nozzle range. This includes everything from standard nozzles to individual nozzles for very specific tasks.



## Cleaning efficiency at a glance

At first sight, finding the right nozzle for your particular application from the variety of nozzles we offer may appear overwhelming. That is why we have defined five cleaning efficiency classes — from a simple rinse to removing the most difficult soil. These individual efficiency classes use information such as tank size and recommended operating pressure to allow you to quickly find the most suitable nozzle for your application.

**You will find a detailed description of the cleaning efficiency classes on page 18.**



## Individual advice

It goes without saying that we provide you with personal service on the subject of tank and equipment cleaning and explain the different possibilities to you. Contact us and let us help you find the best possible solution for the most efficient cleaning.

CONTENT	Page
<b>Applications</b>	<b>4-5</b>
<b>Planning aids</b>	<b>6-18</b>
<b>Cleaning efficiency class 1</b>	<b>19</b>
Series 527	20
Series 540/541	22
Series 5B2/5B3	24
<b>Cleaning efficiency class 2</b>	<b>27</b>
PicoWhirly	28
PVDF MicroWhirly	30
MicroWhirly	32
MiniWhirly	34
NanoSpinner 2	36
MicroSpinner 2	38
MiniSpinner 2	40
MaxiSpinner 2	42
PTFE Whirly	44
PTFE Hi Temp Whirly	46
PopUp Whirly	48
<b>Cleaning efficiency class 3</b>	<b>53</b>
HygienicWhirly	54
Whirly 2	56
Gyro	58
<b>Cleaning efficiency class 4</b>	<b>61</b>
XactClean® HP	62
XactClean® HP +	64
XactClean® HP 2	66
<b>Cleaning efficiency class 5</b>	<b>68</b>
5T2/5T3	69
5TB	71
5TM	73
Rotation monitoring	75
HygienicFit	76
<b>Static cleaning nozzles</b>	<b>77</b>
Series 597	78
PopUp Clean	79
Series 490/491	80
Series 524/525	81
Series 632/633	82
Series 676	84



# LECHLER NOZZLES FOR TANK AND EQUIPMENT CLEANING

## For every application



From the easiest to most difficult soils – Lechler has the optimum solution for removing soils of all kinds.

## Cleaning in Place (CIP)



Many of Lechler's precision nozzles for tank and equipment cleaning are CIP-capable and can remain installed during the production process.



## Hygienic equipment cleaning



Even difficult cleaning tasks with special requirements, such as in the food and beverage industry, can be performed easily with Lechler nozzles.

## The right nozzle for every tank



Our extensive product range includes the right nozzle size for every application – from a small test tube to a large fermentation tank for bioethanol production.

# WHAT YOU SHOULD KEEP IN MIND WHEN PLANNING

## ① The fundamentals of cleaning technology

Sinner's circle  
Cost reduction by efficient cleaning processes

## ② Mechanical cleaning effects with Lechler rotating cleaning nozzles

Mechanical cleaning  
Impact  
Comparison of rotating cleaning nozzles and static spray balls  
Influence of chemistry and temperature  
Foam cleaning with nozzles  
CIP- and SIP-cleaning

## ③ Lechler rotating cleaning nozzles designs

Operating principles  
Connection options  
Materials  
Hygienic requirements  
Nozzle wear  
Material certificates  
ATEX

## ④ Conversion tables

## ⑤ Cleaning efficiency classes

## ① The fundamentals of cleaning technology

### Sinner's circle

The Sinner's circle illustrates the interplay between the four main factors for successful cleaning:

- Chemistry (choice of cleaning agent)
- Mechanical (removal of soil via pressure or friction)
- Temperature (at which cleaning is performed)
- Time (duration of the total cleaning processes)

The proportion of the individual factors as a part of the entire cleaning can be varied, provided that the total is 100 per cent. This results in significant savings potentials.

As a result, the intensification of mechanical cleaning enables the consumption of cleaning agents or the duration of cleaning to be reduced. Consequently, the mechanical factor takes up a greater part of the Sinner's circle, while the other factors can end up being reduced.

### Cost reduction by efficient cleaning processes

This is precisely where our nozzles and rotating cleaning nozzles come into play, having been specially developed for delivering a high mechanical cleaning action. Their greater efficiency helps to permanently reduce on going costs for energy and cleaning agents, and also the duration of cleaning. Consequently a one-off investment in improved nozzle technology pays for itself after only a short time.

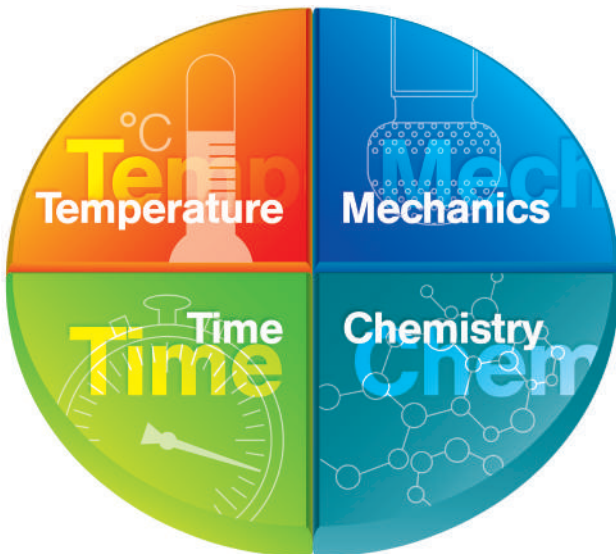

Figure 1: Sinner's circle with equal proportions of the temperature, time, chemistry and mechanical factors.

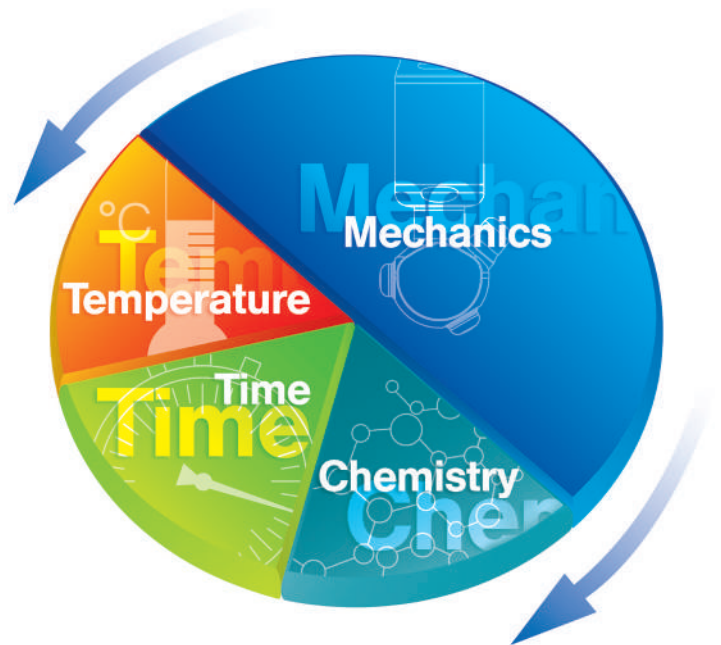

Figure 2: Lechler nozzles and rotating cleaning nozzles have high mechanical cleaning efficiency. This reduces the proportion of the other factors, as well as the resulting costs.

② **Mechanical cleaning effects with Lechler rotating cleaning nozzles**

**Mechanical cleaning**

Rotating cleaning nozzles deliver the greatest impact when cleaning the surface area of the tank. To achieve this, large droplets must strike at high speed. This enables thick soil to be removed that cannot dissolve in the cleaning fluid. Important influencing factors are the distance between the nozzle and wall, and the operating pressure.

If either are too great the fluid will break down into smaller droplets (see Figs. 3 and 4) and the impact will be reduced.

Besides the impact, the fluid running down the tank wall also has a significant cleaning effect. If the formed film is thick enough, the resulting shear stresses can remove light to moderate soil. In that case, unsprayed patches are less of an issue than is the case during impact cleaning (see Fig. 5).

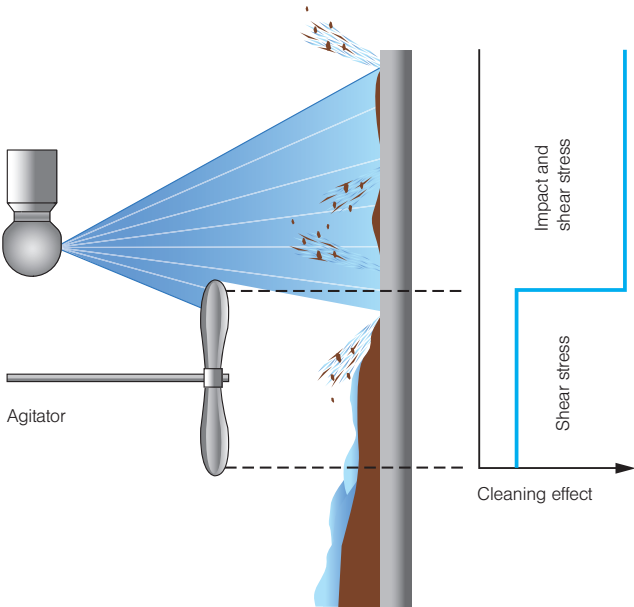

Figure 5: Cleaning mechanisms, impact and shear stress

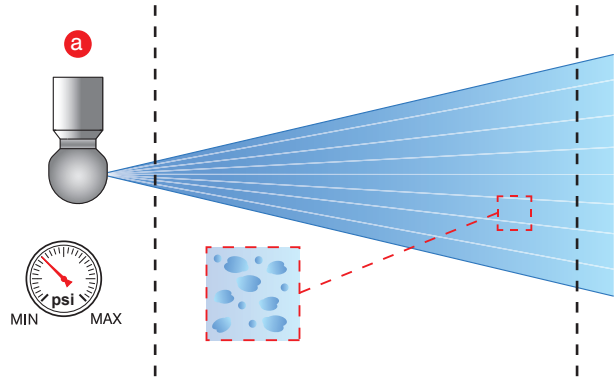

Figure 3: Rotating cleaning nozzles with recommended operating pressure

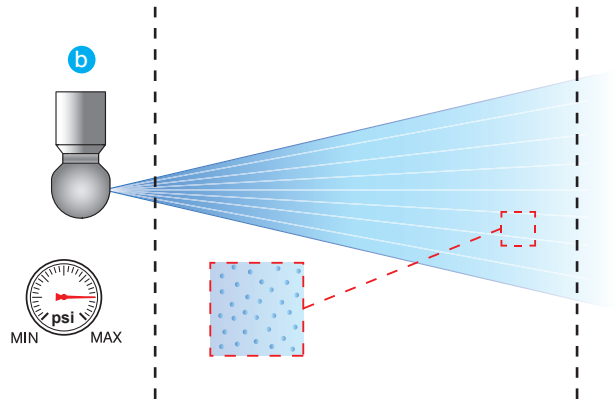

Figure 4: Rotating cleaning nozzles with operating pressure too high



# WHAT YOU SHOULD KEEP IN MIND WHEN PLANNING

## Impact

The force of impact when using a liquid jet on a surface plays an important role in cleaning technology. The ratio of the force (F) to the surface (A) is referred to as the Impact (I).

$$I = \frac{\text{Impact force}}{\text{Impact surface}} = \frac{F}{A} \left[ \frac{\text{lbs}}{\text{in}^2} \right]$$

It can be controlled via the following parameters:

## Impact surface and spray angle (a)

The impact surface is the area where the droplet strikes. The smaller the surface area, the greater the impact values. Nozzles with high impact are, for example, solid stream nozzles and flat fan nozzles with a narrow spray angle (see Fig. 6).

## Flow rate (b)

Increasing the flow rate by using a larger nozzle increases the impact, assuming that the

other parameters (spray angle, pressure and medium) remain the same (see Fig. 6).

## Pressure

In contrast to static cleaning nozzles, there is no linear relationship between pressure and impact for rotating nozzles. With rotating nozzles, the supply pressure normally influences the rotation speed. The higher the rotation speed, the greater the tendency of rotating nozzles to atomize the fluid into much smaller droplets.

This effect has a negative influence on impact. Lechler rotating cleaning nozzles should therefore be used at the recommended operating pressure range.

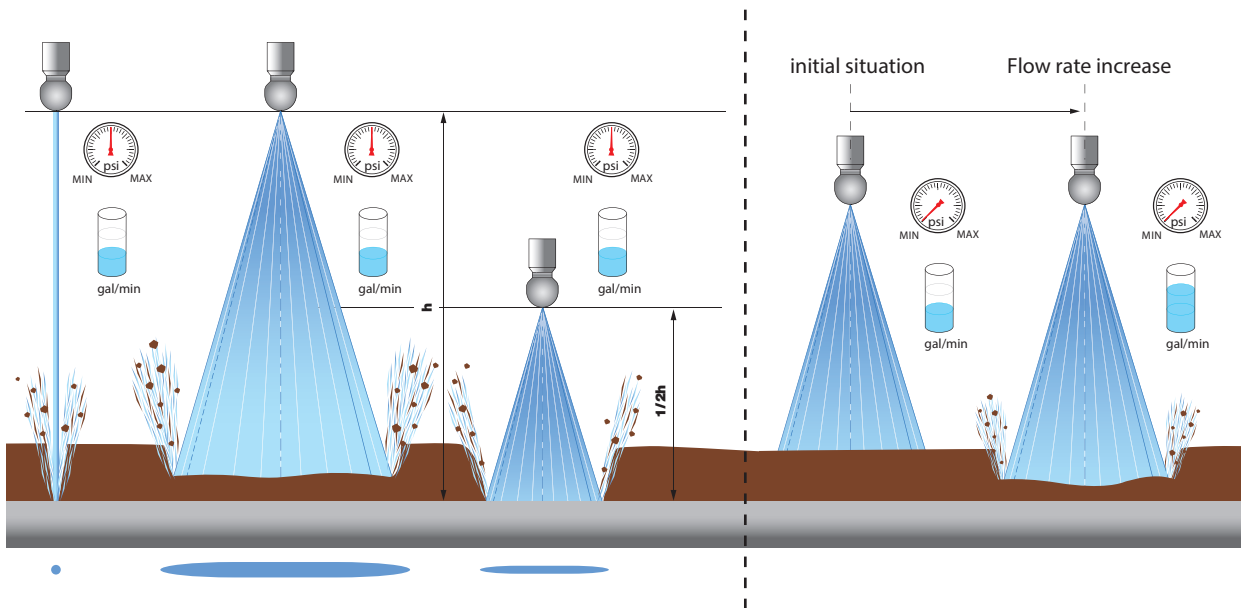

Figure 6:

a) Constant pressure and flow rate, variable spray shape and spray distance

b) Constant pressure, spray shape and spray distance, variable flow rate

### Comparison of rotating cleaning nozzles and static spray balls

Due to their simple construction, static spray balls are economical and are likely to miss important areas. Whereas rotating cleaning nozzles spray the entire tank wall in a fan-like pattern, the

jets from spray balls strike only in concentrated spots. The remaining surface is simply cleaned by the shear stresses of the fluid running off (see Fig. 7). The fluid consumption is therefore significantly greater in comparison to rotating cleaning nozzles.

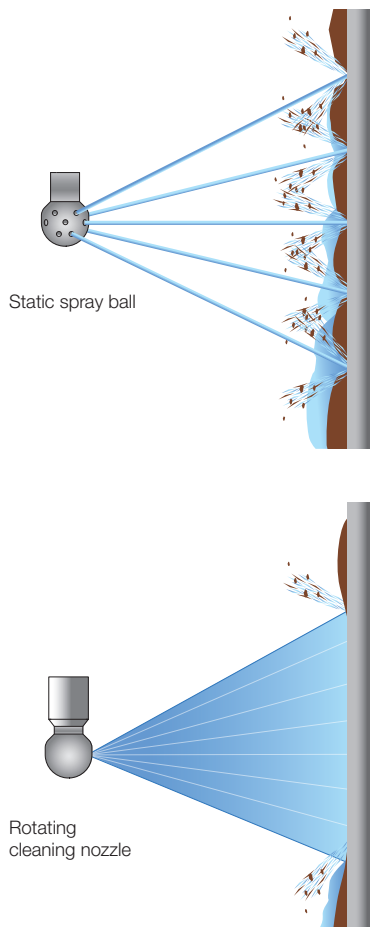

Figure 7: Comparison of rotating cleaning nozzles and static spray balls

### Influence of chemistry and temperature

The chemical cleaning effect takes part in almost all tank cleaning applications when the soil is dissolved in the cleaning medium or the bonding between soil and tank surface is reduced. Higher temperatures can support the chemical cleaning effect.

### Foam cleaning with nozzles

Foam cleaning is primarily based on the chemical cleaning effect. Since the foam sticks more firmly to the surface, it can be more effective than cleaning fluids that drip off quickly. The mechanical cleaning effect plays a correspondingly subordinate role. Here, the task of the nozzle is to distribute the foam evenly. Your end result for this application depends on the type of foam.

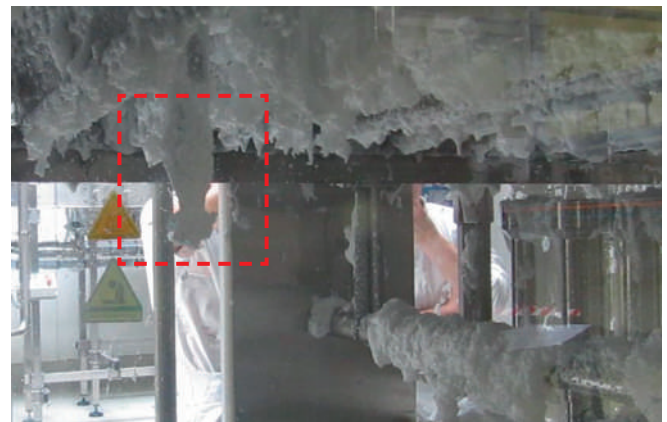

Figure 8: Foam cleaning with a Lechler PVDF MicroWhirly

### CIP- and SIP-cleaning

Cleaning in Place (CIP) is one of the standard cleaning methods in the food and pharmaceutical industries. This is a process where the cleaning and disinfectant solutions circulate in the production systems during the cleaning process. The nozzles are installed in the system and do not need to be dismantled during the process.

The correct combination of steps from Sinner's circle leads to a reliable and reproducible process. Almost all Lechler rotating cleaning nozzles and static spray nozzles are capable of CIP.

If sterilization is performed after CIP-cleaning with hot water or saturated steam, this is referred to as SIP-cleaning (Sterilization in Place).

# WHAT YOU SHOULD KEEP IN MIND WHEN PLANNING

## ③ Lechler rotating cleaning nozzles designs

### Operating principles

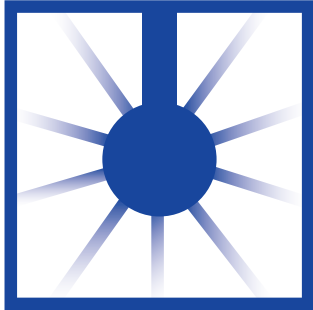

#### Static

Static spray balls do not rotate and therefore require considerably more fluid. They are used primarily for rinsing tanks. They are inexpensive to purchase and are very robust (trouble-free).



#### Free-spinning

The cleaning fluid drives the spray head by means of specially positioned orifices. The rapidly repeated impact removes the soil and rinses it from the tank surface. This results in optimum cleaning efficiency at low pressures in small to medium-sized tanks.

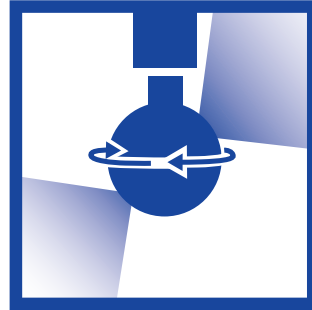

#### Controlled rotation

The rotating head is driven by the fluid. A turbine wheel with an internal gear is used to control the rotation. This ensures that the speed remains in the optimum range even at higher pressures. The droplets produced are larger and strike the tank wall at higher speed. These rotating cleaning nozzles achieve an even higher impact which is especially important for large tanks.

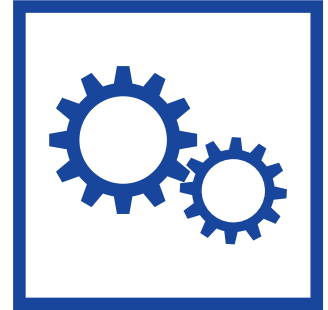

#### Gear-controlled

The cleaning fluid drives an internal gear by means of a turbine wheel so that the spray head rotates by two axes. The solid jet nozzles mounted on the spray head produce powerful jets. These jets sweep the entire tank surface in a pre-programmed, model-specific pattern during a spray cycle. This requires a certain minimum time. These models generate the highest impact and are therefore ideal for very large tanks and the toughest cleaning tasks.



## Connection options

Lechler offers various options for connecting the rotating cleaning nozzles to the supply line:

### Threaded connection

Most nozzles have a female thread that is screwed onto a male thread on the pipe.

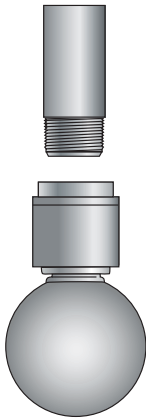

### Slip-on connection

Slip-on connections without threads are often preferred in applications with high sanitary requirements. Here, the nozzle is slipped onto the outer pipe and secured through a horizontal hole by a pin or clamp.

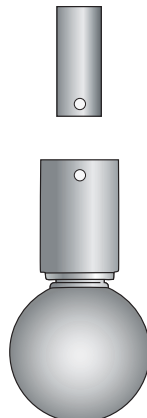

### Tri-Clamp

Tri-Clamp fittings are frequently used in the food and beverage industry. Some rotating cleaning nozzles can be supplied with a compatible adapter.

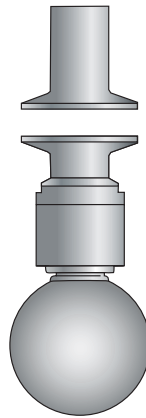

### Welded connection

Welded connections are particularly suitable for applications where sanitary requirements have to be taken into account. Please contact us for further information.

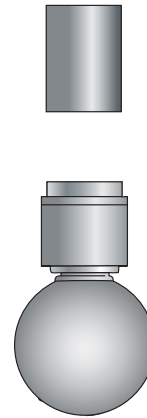

# PERFECT FOR RELIABLE PLANNING

## TankClean SIMULATION SOFTWARE

Planing for a perfect clean tank can be a challenge. Many tanks have built-in equipment such as agitators or baffles which can create spray shadows. Whether a certain nozzle is able to reliably clean all surfaces of the tank under these conditions cannot be decided with certainty on the basis of just a visual inspection.

With our new and unique TankClean software, we can help you to find the optimum solution for perfectly cleaning your tank. To do this, we replicate the tank geometry in the software and then simulate the spraying operation. Operation of all Lechler tank cleaning nozzles can be simulated – from the static spray ball to the high-impact tank cleaning machine. The result of the simulation is documented and provided in a PDF or video file. Simulation with TankClean can already be used as the basis for optimum cleaning in the planning phase of new tanks, but is also suitable for optimizing existing tank cleaning processes.

### Our unique service – your individual benefit

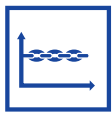

#### Planning certainty

We assist you in planning your tank cleaning solution to ensure cleaning without any gaps.



#### Process optimization

By simulating the existing cleaning processes, we show you the optimization potentials for these processes.

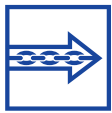

#### Process reliability

Thanks to realistic and individually customized process simulation, we can offer you individual solution concepts.



#### Cost and time savings

Simulation makes it possible to detect any potential problem areas before final definition of the cleaning concept. This makes it possible to significantly reduce the number of time- and cost-intensive practical cleaning tests.

**NEW**

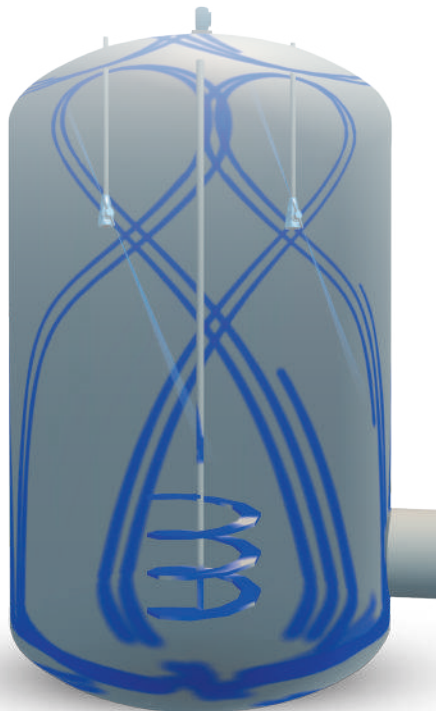

**TankClean**



**Function video**

Scan the QR-code or go to:  
[www.lechler.de/TankCleanGB](http://www.lechler.de/TankCleanGB)



Individual adaptation of tank geometries and built-in equipment

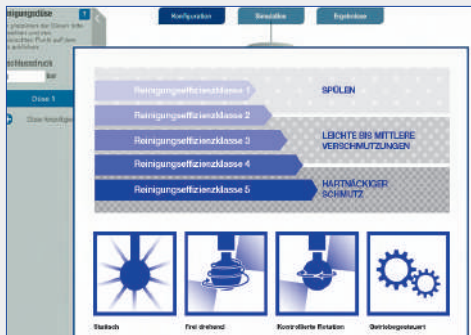

Selection of the right tank cleaning nozzles

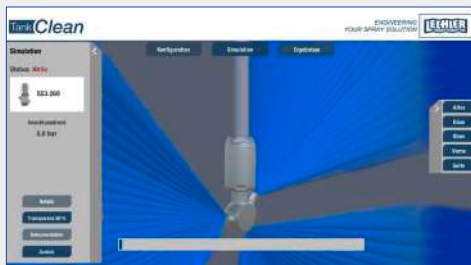

Realistic simulation of the cleaning process



Documentation of the simulation results, including additional planning aids

## Talk to us



Are you interested in tank cleaning simulations with TankClean? Ask your Lechler contact person for further information or give us a call. We will gladly help you in planning your tank cleaning solution.



# WHAT YOU SHOULD KEEP IN MIND WHEN PLANNING

## Materials

Lechler tank and equipment cleaning nozzles are made of extremely high-grade materials that are designed to meet requirements such as resistance to cleaning chemicals or temperature influences. The large choice of different materials — e.g. stainless steel AISI 316L, PVDF, PEEK or PTFE — allows nozzle selection customized to the individual application and operating conditions. In addition, the materials used for the tank and equipment cleaning nozzles are perfectly matched to each other and are characterized by very low wear.

The product pages for the individual nozzles provide information on the materials available for the different nozzle types.

In addition to the requirements for material resistance and wear, the materials must also be food grade for use in the beverage, food and pharmaceutical industries. Depending on the application area, the materials must meet different demands.

A large number of the materials used for Lechler tank and equipment cleaning nozzles

comply with the requirements of the FDA or conform to (EC) 1935/2004.

Further information on conformity is provided on the product pages.



The FDA, the U.S. Food & Drug Administration, is a federal agency which oversees those two industries. Materials used in making Some of Lechler's products comply with the requirements of FDA regulation 21 CFR for use in food applications.



The regulation (EC) No. 1935/2004 of the European Parliament

regulates general safety requirements to all food and beverage contact materials.

Within this regulation, it is additionally stipulated that plastics must comply with (EU) 10/2011.

**The respective logo on the product pages indicates which requirements are met.**

## Hygiene requirements

Lechler's tank and equipment cleaning nozzles are designed so that they meet hygiene requirements.

This is reflected, for example, in the self-draining function, minimized dead space in the nozzles as well as an external design without unnecessary gaps and edges. At the same time, the nozzles are designed with the lowest possible surface roughness.

Lechler also offers specially certified nozzles for particular hygiene requirements. For example, the "PTFE Whirly" and 527 series are 3A-certified.



3-A<sup>®</sup> Sanitary Symbol Council Administrative Council for Spray Cleaning Devices (78-01)

3-A<sup>®</sup> SSI is an independent, not-for-profit corporation

dedicated to advancing hygienic equipment design for the food, beverage, and pharmaceutical industries. The display of the 3-A symbol requires that processing equipment meets certain material, design, and fabrication standards for cleanability and inspection.

**The respective logo on the product pages indicates which requirements are met.**

## Nozzle Wear

Nozzle wear depends mainly on the operating conditions.

Like with all rotating parts, the bearing assembly is subjected to the highest amount of stress. The following operating conditions accelerate wear:

- Solids in the fluid and hard particles
- Use in a chemically aggressive environment
- Spraying of chemically aggressive substances
- Operating the nozzle above the recommended pressure range or temperature.

## Material certificates

Material certificates in accordance with DIN EN 10204 can be issued on request for almost all Lechler tank and equipment cleaning nozzles.

## ATEX



Lechler offers specially designed nozzle series for use in explosive atmospheres. The "MicroWhirly" and "Whirly" series have an ATEX approval that was issued by an external certification institute.

#### ④ Conversion tables

##### p Pressure

Unit	Conversion			
	bar	Pascal [Pa] = N/m <sup>2</sup>	psi	lb/sq ft
<b>1 bar</b>	1	1·10 <sup>5</sup>	14.5	2089
<b>1 Pascal [Pa]</b>	1·10 <sup>-5</sup>	1	14.5·10 <sup>-5</sup>	0.0209
<b>1 psi</b>	0.06895	6895	1	144
<b>1lb/sq ft</b>	0.479·10 <sup>-3</sup>	47.9	6.94·10 <sup>-3</sup>	1

##### V Volume

Unit	Conversion			
	l	m <sup>3</sup>	Imp. gal	US gal
<b>1 l (1 dm<sup>3</sup>)</b>	1	1·10 <sup>-3</sup>	0.22	0.264
<b>1 m<sup>3</sup></b>	1000	1	220	264.2
<b>1 Imp. gallon</b>	4.546	4.546·10 <sup>-3</sup>	1	1.201
<b>1 US gallon</b>	3.785	3.785·10 <sup>-3</sup>	0.8327	1

##### V̇ Flow rate

Unit	Conversion				
	l/min	l/s	m <sup>3</sup> /h	US gal/min	Imp. gal/min
<b>1 l/s</b>	60	1	3.6	15.85	13.20
<b>1 l/min</b>	1	0.01667	0.06	0.2642	0.22
<b>1 m<sup>3</sup>/h</b>	16.67	0.28	1	4.40	3.66
<b>1 US gal./min</b>	3.785	0.0631	0.227	1	0.8327
<b>1 Imp. gal./min</b>	4.546	0.076	0.273	1.201	1

##### ρ Change in specific weight

$\dot{V}_w = \frac{\dot{V}_F}{X}$	$\dot{V}_w = \text{Flow rate (water) [l/min, l/h]}$
$\dot{V}_F = \dot{V}_w \sqrt{\frac{\rho_w}{\rho_F}} = \dot{V}_w \cdot X$	$\dot{V}_F = \text{Flow rate of liquid, with a specific weight that differs from 1}$
$X = \sqrt{\frac{\rho_w}{\rho_F}}$	X = Multiplier ρ = Specific weight [kg/m <sup>3</sup> ]
$\frac{\rho_F}{X}$	500 600 700 800 900 1000 1100 1200
	1.41 1.29 1.20 1.12 1.06 1.0 0.95 0.91
$\frac{\rho_F}{X}$	1300 1500 1600 1700 1800 1900 2000
	0.88 0.85 0.82 0.79 0.77 0.75 0.73 0.71

##### p/V Pressure/Flow rate

Valid for <b>single-fluid nozzles and rotating nozzles</b> except for axial-flow full cone nozzles	$\dot{V}_2 = \sqrt{\frac{p_2}{p_1}} \cdot \dot{V}_1 [\text{gpm}]$	Ratio of both, given and required pressure — flow rate values
	$p_2 = \left(\frac{\dot{V}_2}{\dot{V}_1}\right)^2 \cdot p_1 [\text{psi}]$	
Valid for <b>axial-flow full cone nozzles</b>	$\dot{V}_2 = \left(\frac{p_2}{p_1}\right)^{0.4} \cdot \dot{V}_1 [\text{gpm}]$	
	$p_2 = \left(\frac{\dot{V}_2}{\dot{V}_1}\right)^{2.5} \cdot p_1 [\text{psi}]$	

**All flow rate data of this brochure have been measured with water and consider the individual flow parameters of the nozzle designs.**

# WHAT YOU SHOULD KEEP IN MIND WHEN PLANNING

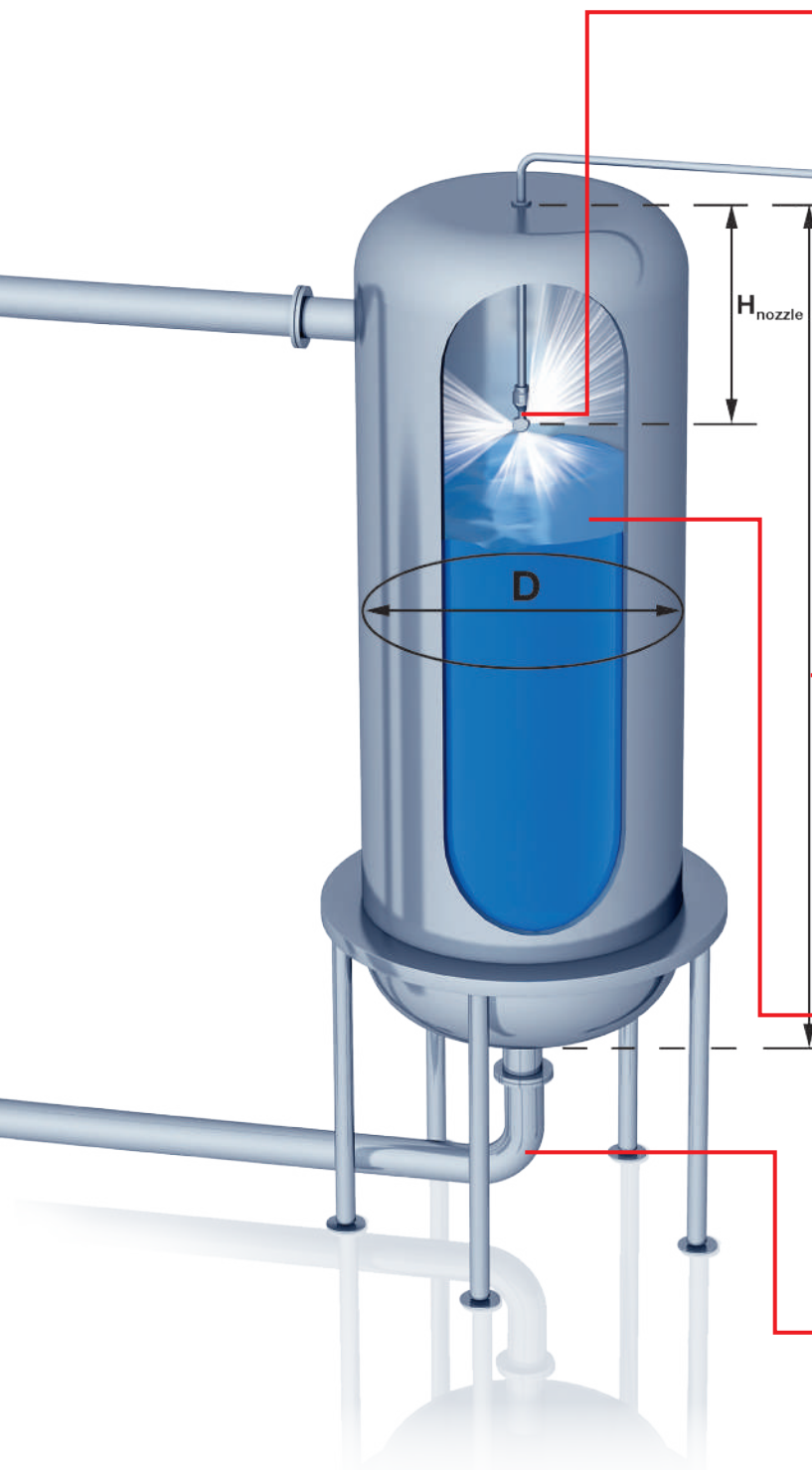

## Nozzle selection

Choosing the right Lechler rotating cleaning nozzle or static spray ball is determined primarily by the type of soil to be cleaned and the tank diameter. You can find this information on the product pages. It must be guaranteed that the diameter of the tank to be cleaned is smaller than the specified maximum possible tank diameter of the nozzles.

## Pump and pipes

The pipe size used depends mainly on the required flow rate and should be chosen so that the pressure losses in the pipe system are as low as possible. It must be guaranteed that the required static operating pressure is available directly at the nozzle. The pump power must be matched to this.

## Arrangement

The nozzles must be positioned in the upper part of the tank where possible. The following recommendation applies:

$$H_{\text{nozzle}} = 1/3 \cdot H_{\text{tank}} \text{ and } H_{\text{nozzle}} < 1/3 \cdot D_{\text{max spray diameter nozzle}}$$

In addition, it must be ensured that sufficient cleaning fluid strikes the tank top.

## Filling level

If possible, the nozzle should not come into contact with the product during production. The nozzle should be positioned above the maximum product level in the tank.

## Tank drainage rate

The tank drainage rate is to be selected to prevent the level of liquid from rising during the cleaning process. Make sure the drain can handle whatever volume you put into the tank. (See chart on the right)

1"	6 gal/min
1 1/2"	13 gal/min
2"	23 gal/min
2 1/2"	35 gal/min
3"	50 gal/min
4"	87 gal/min
5"	141 gal/min
6"	204 gal/min

### Number of nozzles

When cleaning large tanks or complex installations, you will need to install several nozzles. The nozzles must be positioned for the spray jets to overlap. These nozzles effectively clean the tank surface area.

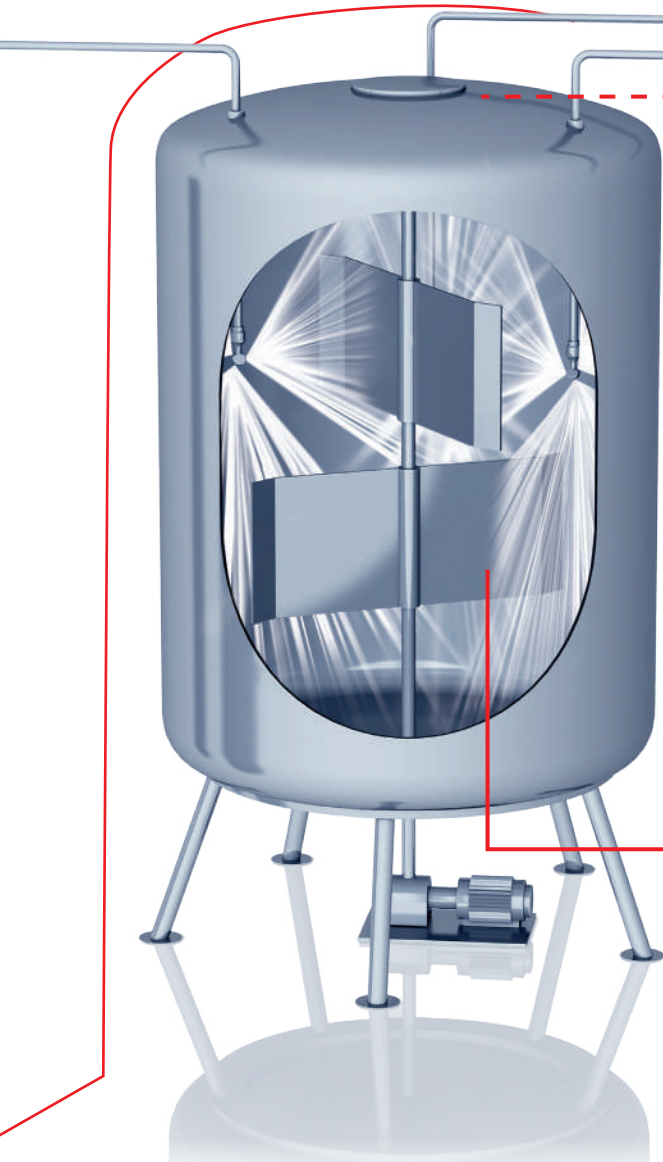

### Avoidance of spray shadows

Installations such as agitators, baffle plates or pipes prevent the areas behind them from being reached directly by the spray jet. Impact cleaning is not possible in these locations. For this reason, several nozzles must be installed if the tank contains equipment such as agitators or pipes. The number of nozzles should be chosen so that the spray shadows of the individual nozzles are eliminated. In addition, static spray nozzles can also be used for targeted removal of deposits left as a result of spray shadows or in areas that are difficult to clean.

# WHAT YOU SHOULD KEEP IN MIND WHEN PLANNING



## ⑤ Cleaning efficiency classes

Lechler precision nozzles for tank and equipment cleaning are divided into five different cleaning efficiency classes.

Every nozzle from Lechler is assigned to a class. These classes make it possible to find the right nozzle for the respective application. The subdivision into cleaning efficiency classes 1 to 5 is intended to facilitate nozzle selection for users. The respective class is suitable for specific cleaning tasks.

First, the required cleaning efficiency class is defined on the basis of the soil type —

rinsing, light to medium soil, and persistent soil. Several classes are generally always suitable for one type of soiling. It is not possible or expedient to differentiate exactly between the soil types or recommended nozzle types since there are a large number of different applications. The information should be seen as recommendations intended to make it easier to choose the right nozzle.

If your application is to clean a non-adhering powder material from a tank surface, for example, the cleaning task can be defined as “rinsing.”

The nozzle series in cleaning efficiency class 1, e.g. static

spray ball, or class 2, e.g. MicroWhirly or MiniSpinner, are suitable for this. In the next step, the maximum possible tank diameter and the flow rate range of the individual series are considered. Lechler static spray balls are very economical. For cleaning medium soil, Lechler MicroSpinners or MiniSpinners are recommended.

However, it is also possible that there will be no nozzle series from the two cleaning efficiency classes that is suitable at first sight in the case of very large tanks. To check this, it is recommended to refer to the overview page of the respective cleaning efficiency class. Using

the number line, it is possible to see at a glance whether there is a suitable series for the specific tank diameter in the corresponding cleaning efficiency class. The following possibilities exist if there is no recommended series for the required tank diameter:

- Several nozzles are positioned in the tank so that the distance between nozzle and tank is within the required dimensions.
- By referring to the overview pages of the different cleaning efficiency classes, choose a suitable nozzle series for the respective tank diameter.

### Static cleaning nozzles

In addition to the classes described above, there is also an additional subdivision into static cleaning nozzles. These include flat fan or full cone nozzles, for example. These can be used for the shadowing effect to provide complete spray coverage.





# RELIABLE RINSING OF TANKS AND EQUIPMENT INSTALLATIONS



## Cleaning efficiency class 1

These static spray balls of cleaning efficiency class 1 are designed for hygienic rinsing with a flow rate of 4.0 to 89 gpm at 20 psi, as is frequently required in the food and beverage industry. In addition to liquid media, the static spray balls can also be operated with media such as steam and air and

are also especially suitable for SIP-cleaning (Sterilization in Place).

Lechler products in this class are also designed for operation at higher temperatures and guarantee high process reliability.



**Operating principles**  
Static

**Flow rates at 30 psi**  
4.0 to 177 gpm

**Recommended operating pressures**  
20-40 psi

**Max. temperatures**  
to 392°F/ 200°C



# Static spray balls Series 527

## Series 527

Series 527 complies with 3-A® standards and makes this product suitable for hygienic applications. They clean with powerful solid jets, have a high surface quality and are also reliably resistant to high temperatures.

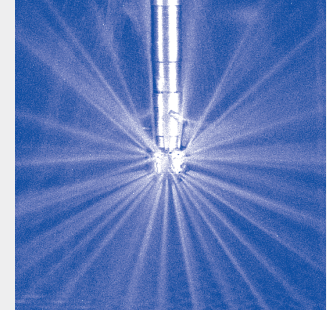

**Material**  
AISI 316L SS

**Max. temperature**  
392°F/ 200°C

**Recommended operating pressure**  
20 psi

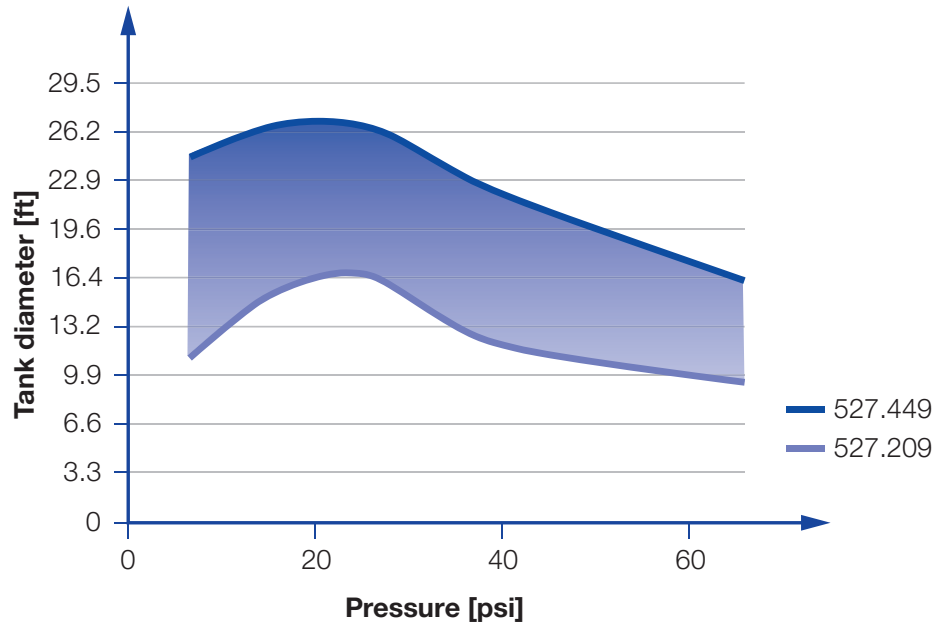

**Installation**  
Operates in every direction

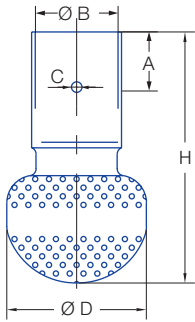

Overview of the tank diameter, depending upon the pressure of series 527



**Slip-on connection  
ASME - BPE 1997 (OD-Tube)**

Spray angle 	Ordering no.	Free Passage (in.)	Flow Rate (Gallons Per Minute)				Dimensions approx. (in.)					Max. tank diameter [ft]
			20 psi	40 psi	2 bar	60 psi	Height H (in.)	Diameter D (in.)	B	C	A	
	<b>527. 209. 1Y. 00. 75</b>	.031	13	19	60	23	2.7	1.3	.75	.13	.50	17
	<b>527. 289. 1Y. 01. 50</b>	.043	37	53	170	65	4.6	2.6	1.51	.19	1.00	20
	<b>527. 449. 1Y. 02. 00</b>	.067	92	130	420	160	6.0	4.0	2.01	.19	1.00	27

**The maximum tank diameter shown above applies for the recommended operating pressure and is indicative only. The cleaning result is also affected by the type of soiling.**

### Information on operation

In most applications, static spray balls do not deliver the same cleaning power as rotating nozzles, however, they do have advantages that make them indispensable for certain tasks:

- No moving parts
- Self-draining
- Easy to inspect
- Proven use in hygienically sensitive environments

If for some reason, a rotating nozzle should stop turning, parts of the tank may remain uncleaned. This will not happen with spray balls. However, gaps can occur in the spray pattern if individual openings are blocked with soil.

Compared to rotating nozzles, static spray balls usually need two to three times the amount of liquid.

### Slip-on information

- R-clip made of stainless steel AISI 316L is included.
- Depending on diameter of the adapter the flow rate can increase due to leakage between the connection and static spray ball.



# Static spray balls Series 540 / 541

## Series 540 / 541

The robust series 540 / 541 have a threaded connection and an especially compact design. They can also be used at high temperatures as well as for the output of steam and air.

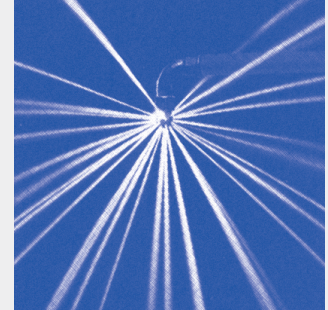
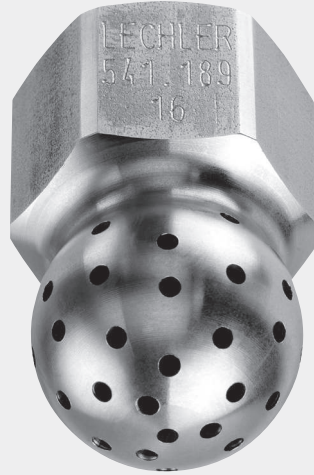

**Max. tank diameter [ft]**



**Material**  
AISI 303 SS



**Max. temperature**  
392°F / 200°C



**Recommended operating pressure**  
40 psi



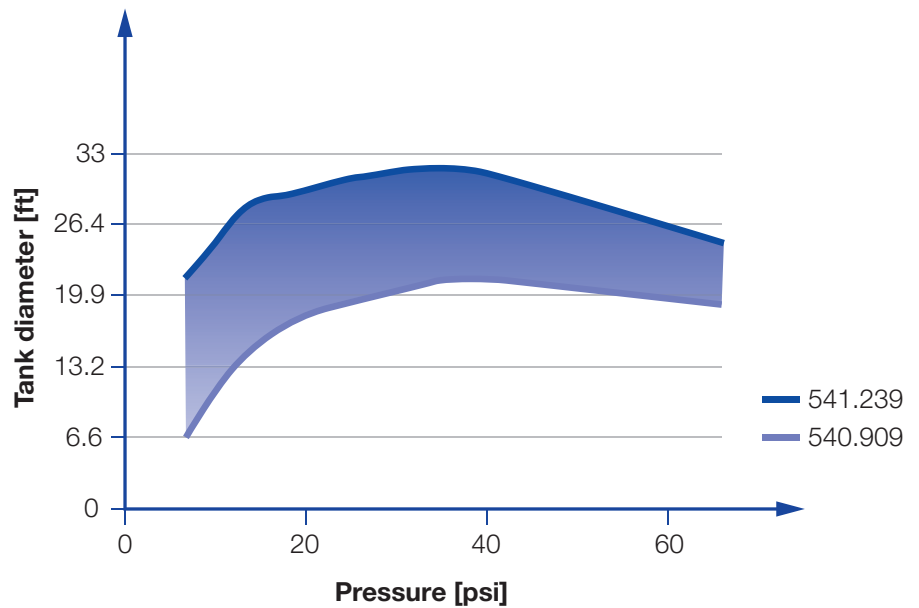

**Installation**  
Operates in every direction



Overview of the tank diameter, depending upon the pressure of series 540 / 541

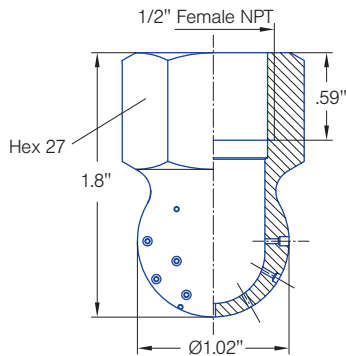



Spray angle 	Ordering no.	Free Passage (in.)	Flow Rate (Gallons Per Minute)				Max. tank diameter [ft]
			20 psi	40 psi	liters per minute 2 bar	60 psi	
240° 	<b>540. 909. 16. BH</b>	.031	4	6	18	7	21
	<b>540. 989. 16. BH</b>	.039	6	9	28	11	23
	<b>541. 109. 16. BH</b>	.059	13	18	57	22	25
	<b>541. 189. 16. BH</b>	.079	20	28	90	34	27
	<b>541. 239. 16. BH</b>	.090	26	37	118	45	31

\*Note; BSPP threads available upon request

**The maximum tank diameter shown above applies for the recommended operating pressure and is indicative only. The cleaning result is also affected by the type of soiling.**

### Information on operation

In most applications, static spray balls do not deliver the same cleaning power as rotating nozzles, however, they do have advantages that make them indispensable for certain tasks:

- No moving parts
- Self-draining
- Easy to inspect
- Proven use in hygienically sensitive environments

If for some reason, a rotating nozzle should stop turning, parts of the tank may remain uncleaned. This will not happen with spray balls. However, gaps can occur in the spray pattern if individual openings are blocked with soil.

Compared to rotating nozzles, static spray balls usually need two to three times the amount of liquid.

1  
Cleaning efficiency class

2  
Cleaning efficiency class

3  
Cleaning efficiency class

4  
Cleaning efficiency class

5  
Cleaning efficiency class

Static cleaning nozzles



# Static spray balls »RinseClean« Series 5B2/5B3

## Series 5B2/5B3

The spray ball design has proven itself in many applications. It can be used in areas with high hygienic requirements and high temperatures. Our RinseClean spray ball is available with various slip-on connections, as well as in threaded or welded versions.

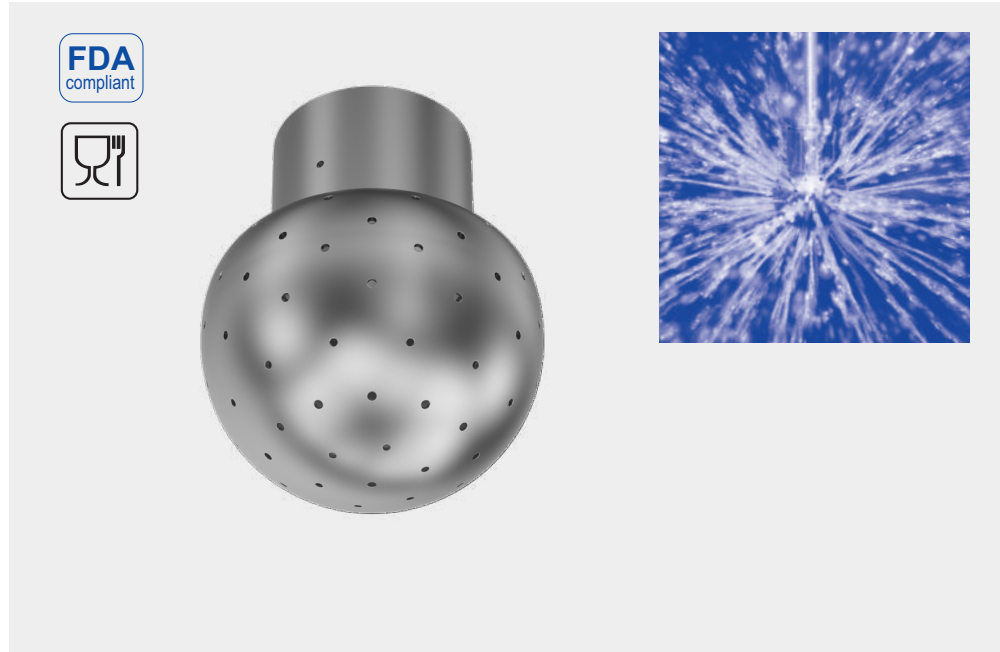

**Material**  
316L SS,  
R-clip: 316L SS

**Max. temperature**  
392 °F / 200 °C

**Recommended operating pressure**  
30 psi

**Installation**  
Operation in every direction is possible

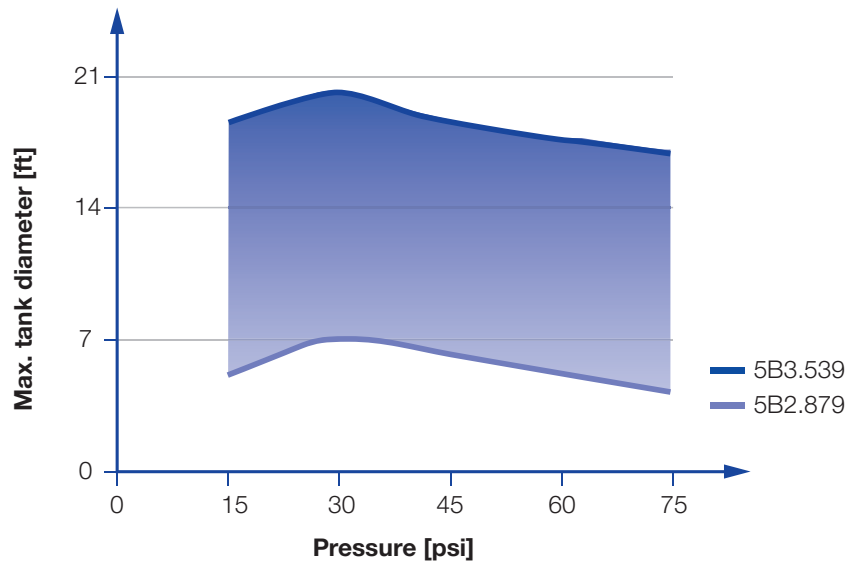

Overview of the tank diameter, depending upon the pressure of series 5B2/5B3

## Slip-on connection

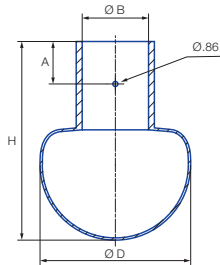

Dimensions slip-on connection according to DIN 10357



Pin 1

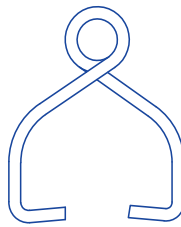



Pin 2-5

With the slip-on connection, the spray ball is pushed onto the customer's connection pipe and secured with the supplied cotter pin. Lechler offers the right connection sizes for the three most common pipe standards.

Pin	Ordering no.
1	095.013.1Y.06.55.0
2	095.013.1Y.06.58.0
3	095.013.1Y.06.56.0
4	095.013.1Y.06.59.0
5	095.013.1Y.06.57.0

## Slip-on connection according to DIN EN 10357 series D (ASME BPE 1997, OD tube compatible)

Spray angle 	Ordering no. Type	E Ø [in]	Flow Rate (Gallons per minute)					Dimensions [in]					Max. tank diameter [ft]
			20 psi	30 psi	liters per minute 2 bar	40 psi	60 psi	Ø D	Height H	Con-nection B	Distance to bore hole A	Pin	
360° 	5B3.089.1Y.A1.00.0	.04	10.9	13.4	50	15.5	19	1.10	1.65	0.39	.35	1	7
	5B3.209.1Y.A1.90.0	.06	22.0	26.9	100	31.0	38	1.10	1.65	0.76	.35	1	8
	5B3.309.1Y.A1.90.0	.07	39.4	48.4	180	55.9	68.4	2.52	3.31	0.76	.71	2	11
	5B3.379.1Y.A2.60.0	.08	57.1	69.9	260	80.7	98.8	2.52	3.31	1.01	.71	3	17
	5B3.449.1Y.A3.80.0	.12	89.9	110.2	410	127.2	155.8	2.52	3.31	1.51	.71	3	18
	5B3.539.1Y.A5.10.0	.13	147.0	180	670	207.9	254.6	3.54	4.37	2.01	.98	5	18

E = narrowest free cross-section

The maximum tank diameter shown above applies for the recommended operating pressure and is indicative only. The cleaning result is also affected by the type of soiling.



### Slip-on information

- Pin made of 316L SS is included.
- Depending on diameter of adapter, the flow rate can increase due to leakage between connecting pipe and static spray ball.

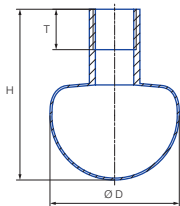
## Threaded connection



## Female Threaded connection

Spray angle 	Ordering no. Type	Con-nection NPT	E Ø [in]	Flow Rate (Gallons per minute)					Dimensions [in]			Max. tank diameter [ft]
				20 psi	30 psi	liters per minute 2 bar	40 psi	60 psi	Ø D	Height H	Screw-in length T	
360° 	5B2.879.1Y.BB.00.0	1/8"	.03	3.4	4.0	15	4.7	5.7	.79	1.5	.31	7
	5B3.309.1Y.BH.00.0	1/2"	.07	39.5	48.4	180	55.9	68.4	2.5	3.3	.55	11
	5B3.379.1Y.BN.00.0	1"	.08	57.1	69.9	260	80.7	98.8	2.5	3.3	.71	17
	5B3.539.1Y.BW.00.0	2"	.12	147.0	180.0	670	207.9	254.6	3.5	4.4	.94	18

E = narrowest free cross-section

The maximum tank diameter shown above applies for the recommended operating pressure and is indicative only. The cleaning result is also affected by the type of soiling.





# PERFECT RINSING AND REMOVAL OF LIGHT SOILING

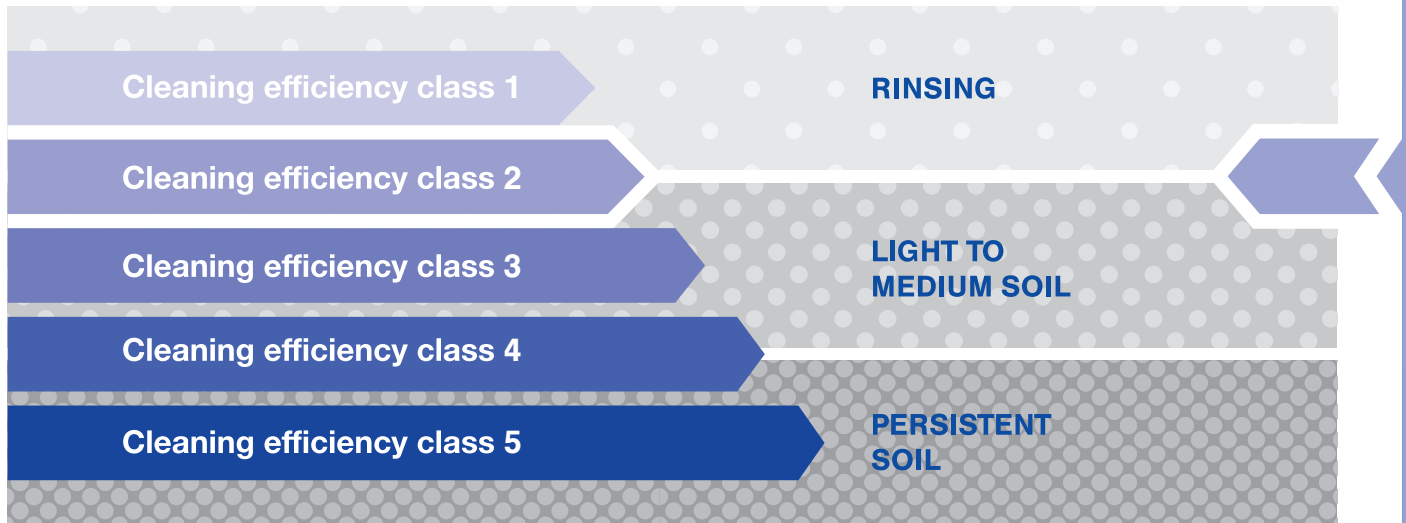

## Cleaning efficiency class 2

The typical task profile of the rotating nozzles in cleaning efficiency class 2 includes rinsing and the removal of light soiling, particularly the kind that frequently occurs in the food and beverage industry, as well as the chemical and pharmaceutical industry.

The Lechler products in this class are free-spinning and made from high-grade materials such as stainless steel, PVDF, PEEK and PTFE. This allows a wide range of various cleaning agents to be used.



	<b>Max. tank diameter [ft]</b>	0	5	10	15	20	25	30
--	--------------------------------	---	---	----	----	----	----	----

**Operating principles**  
Free-spinning

**Flow rates at 30 psi**  
2 to 59 gpm

**Recommended operating pressures**  
30 to 40 psi

**Max. temperatures**  
122 to 392°F  
50 to 200°C



# Rotating cleaning nozzle "PicoWhirly" Series 500.234

## Series 500.234

The PicoWhirly works with rotating solid jets and is also suitable for cleaning at very high temperatures. This rotating cleaning nozzle with kolsterized slide bearing is made entirely from stainless steel and can also be used in very small spaces, thanks to its extremely compact construction.



**Material**  
AISI 316L SS



**Max. temperature**  
400°F/ 200°C



**Recommended operating pressure**  
40 psi



**Installation**  
Operates in every direction



**Filtration**  
Line strainer with a mesh size of 0.3 mm/50 mesh



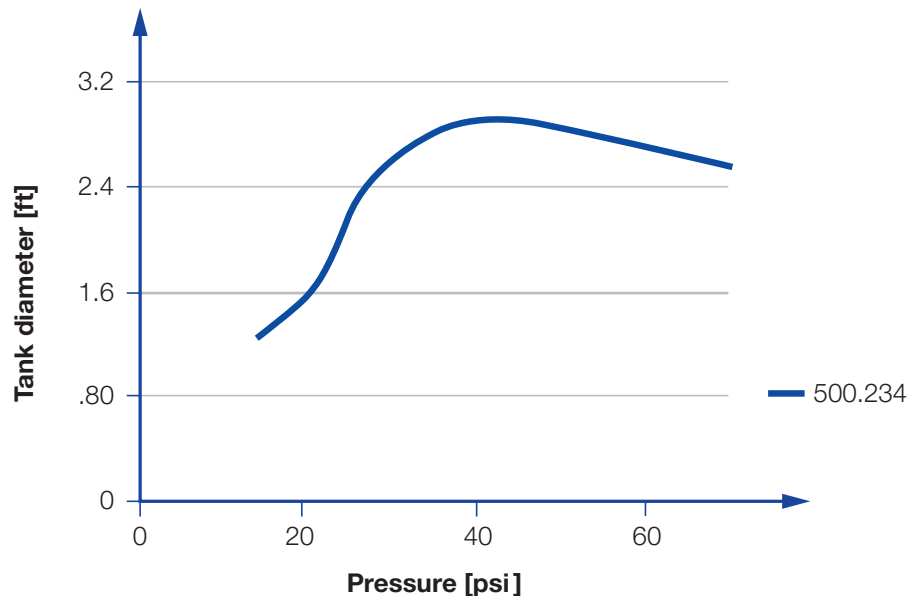

**Bearing**  
Kolsterized Sleeve bearing

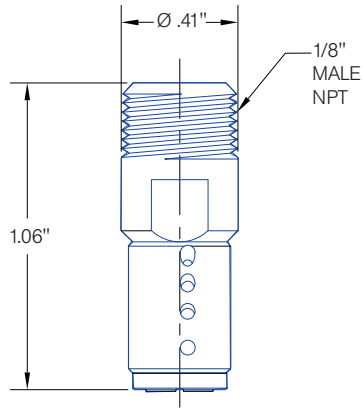

Overview of the tank diameter, depending upon the pressure of series 500.234



Spray angle 	Ordering no.  Connection 1/8" Male NPT	Free Passage (in.)	Flow Rate (Gallons Per Minute)				Max. tank diameter [ft]
			20 psi	liters per minute 2 bar	40 psi	60 psi	
300° 	<b>500. 234. G9. BA</b>	.07	1.8	8	2.5	3.0	3

The maximum tank diameter shown above applies for the recommended operating pressure and is indicative only. The cleaning result is also affected by the type of soiling.

### Information on operation

- Operation with compressed air or steam purge only for short-term usage. Operation above the recommended operating pressure means higher wear and smaller droplets. This might have adverse effects on the cleaning result.

2  
Cleaning efficiency class

3  
Cleaning efficiency class

4  
Cleaning efficiency class

5  
Cleaning efficiency class

Static cleaning nozzles



# Rotating cleaning nozzle “PVDF MicroWhirly” Series 500.191

## Series 500.191

The PVDF MicroWhirly is made entirely from PVDF and designed to work in a corrosive environment. It is also suitable for contact with food and the application of foam, and can be used for cleaning equipment – all for a very good price-performance ratio.



	<b>Max. tank diameter[ft]</b>	0	5	10	15	20	25	30
--	-------------------------------	---	---	----	----	----	----	----



**Material**  
PVDF



**Max. temperature**  
194°F/ 90°C



**Recommended operating pressure**  
30 psi



**Installation**  
Operates in every direction



**Filtration**  
Line strainer with a mesh size of 0.3 mm/50 mesh



**Bearing**  
Sleeve bearing made of PVDF

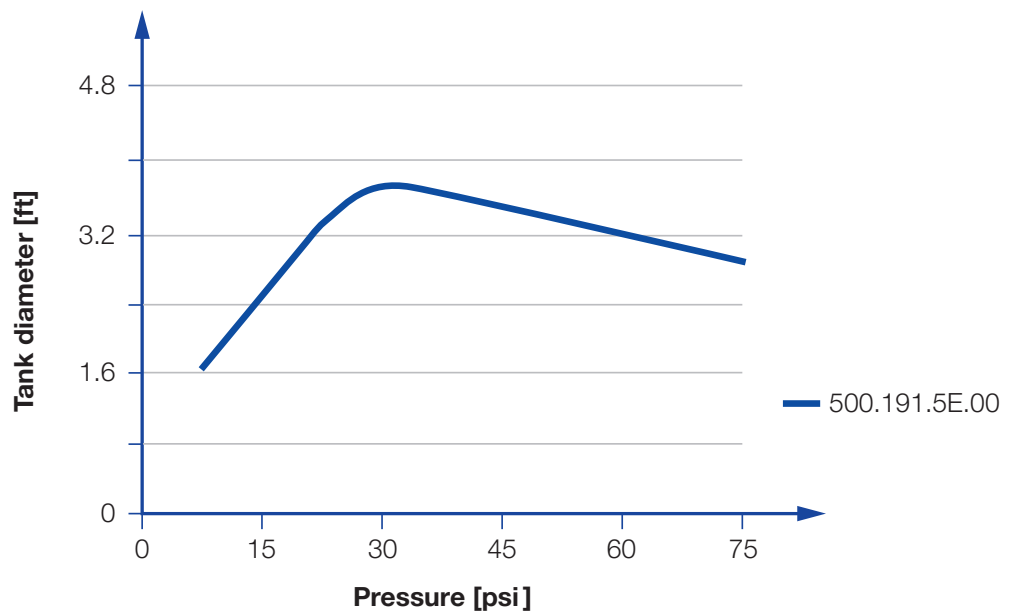

Overview of the tank diameter, depending upon the pressure of series 500.191



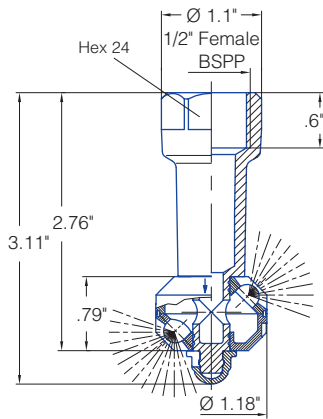



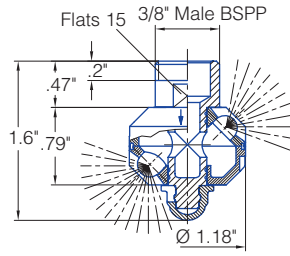

Standard version



Compact version

### Standard version

Spray angle 	Ordering no.	Free Passage (in.)	Connection	Flow Rate (Gallons Per Minute)					Max. tank diameter [ft]
				20 psi	30 psi	liters per minute 2 bar	40 psi	60 psi	
180° 	500. 191. 5E. 02	.086	1/2" Female BSPP	2.9	3.5	13	4.0	4.9	2.6
180° 	500. 191. 5E. 01	.086	1/2" Female BSPP	2.9	3.5	13	4.0	4.9	2.6
360° 	500. 191. 5E. 00	.086	1/2" Female BSPP	4.4	5.4	20	6.2	7.6	3.6

The maximum tank diameter shown above applies for the recommended operating pressure and is indicative only. The cleaning result is also affected by the type of soiling.

### Compact version

Spray angle 	Ordering no.	Free Passage (in.)	Connection	Flow Rate (Gallons Per Minute)				Max. tank diameter [ft]
				20 psi	liters per minute 2 bar	40 psi	60 psi	
180° 	500. 191. 5E. 21	.086	3/8" Male BSPP	2.9	13	4.0	4.9	2.6
360° 	500. 191. 5E. 22	.086	3/8" Male BSPP	4.4	20	6.2	7.6	3.6

### Information on operation

- The PVDF MicroWhirly is not suitable for operation with compressed air or any other gas.
- Operation above the recommended operating pressure has negative effects on the cleaning result and wear

The maximum tank diameter shown above applies for the recommended operating pressure and is indicative only. The cleaning result is also affected by the type of soiling.



# Rotating cleaning nozzle “MicroWhirly” Series 566

## Series 566

The MicroWhirly, with effective flat fan nozzles, is licensed for contact with food. Thanks to the robust slide bearing made from PEEK, the MicroWhirly has a particularly long service life. The MicroWhirly is alternatively available with an internal or external thread and in an ATEX version, which allows it to be adapted to a wide range of uses.



	<b>Max. tank diameter [ft]</b>	0	5	10	15	20	25	30
--	--------------------------------	---	---	----	----	----	----	----



**Materials**  
AISI 316L SS, PEEK,  
PEEK ESD (ATEX  
version only)



**Max. temperature**  
266°F/ 130°C  
194°F/ 90°C ATEX Version



**Recommended operating pressure**  
40 psi



**Installation**  
Operates in every direction



**Filtration**  
Line strainer with  
a mesh size of  
0.3 mm/50 mesh  
0.2 mm/80 mesh  
ATEX Version



**Bearing**  
Sleeve bearing  
made of PEEK

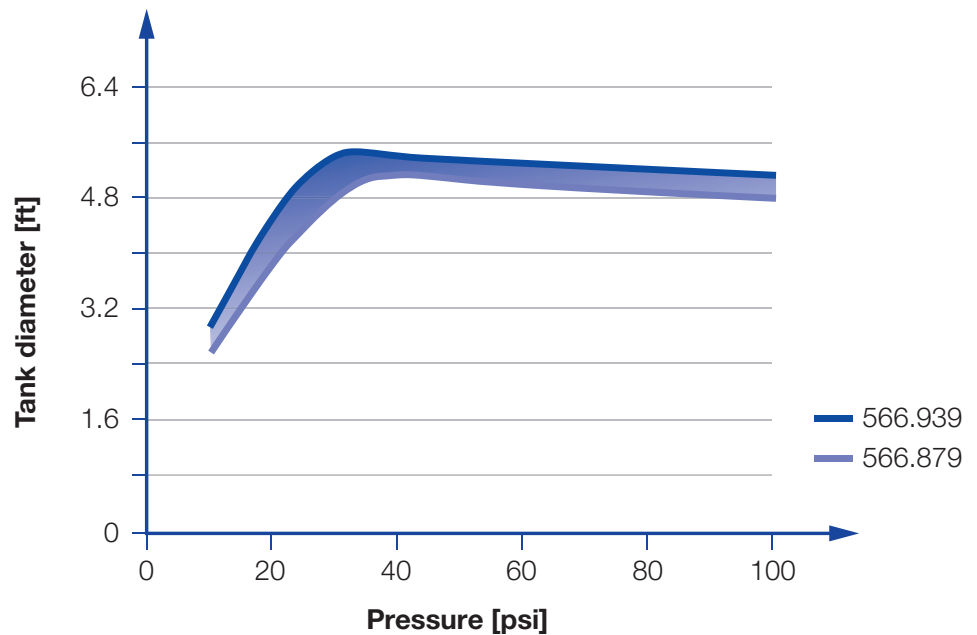

Overview of the tank diameter, depending upon the pressure of series 566

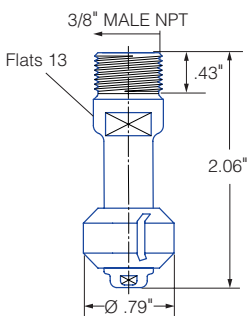

3/8" Male NPT

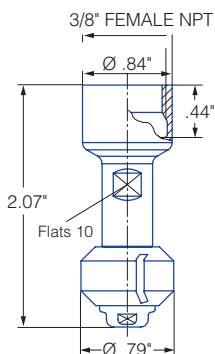

3/8" Female NPT

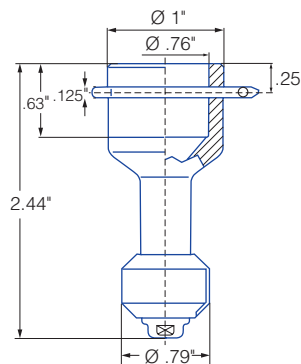

Slip-on connection  
3/4" OD Slip-on

Spray angle 	Ordering no.				Free Passage (in.)	Flow Rate (Gallons Per Minute)				Max. tank diameter [ft]	
	Type	Connection				20 psi	liters per minute	2 bar	40 psi		60 psi
		3/8" Male NPT	3/8" Female NPT	3/4" OD Slip-on							
180° 	566. 873. 1Y	BE	BF	TF07	.04	3.3	15	4.7	5.7	5.2	
	566. 933. 1Y	BE	BF	TF07	.04	4.6	21	6.5	8.0	5.6	
180° 	566. 874. 1Y	BE	BF	TF07	.04	3.3	15	4.7	5.7	5.2	
	566. 934. 1Y	BE	BF	TF07	.04	4.6	21	6.5	8.0	5.6	
360° 	566. 879. 1Y	BE	BF	TF07	.04	3.3	15	4.7	5.7	5.2	
	566. 939. 1Y	BE	BF	TF07	.04	4.6	21	6.5	8.0	5.6	

The maximum tank diameter shown above applies for the recommended operating pressure and is indicative only. The cleaning result is also affected by the type of soiling.

### Information on operation

- Operation with compressed air purge only for short-term usage. Operation above the recommended operating pressure means higher wear and smaller droplets. This might have adverse effects on the cleaning result.

### Slip-on information

- R-clip made of stainless steel AISI 316L is included (Ordering no.: 095.022.1Y.50.94.E).
- Depending on diameter of the adapter the flow rate can increase due to leakage between the connection and rotating cleaning nozzle.

### Example of ordering with ATEX approval.

#### Unit group / category / zones:

- ⊕ II 1G Ex h LLB T6... T3 Ga
- ⊕ II 1D Ex h IIIC T85 °C...T150 °C Da



Example Type + Connection = Ordering no.  
of ordering: 566.873.1Y.XX.EX + BE = 566.873.1Y.BE.EX

### Example of ordering with FDA and (EG) 1935/2004 conform.



All Materials are suitable for contact with food.



Example Type + Connection = Ordering no.  
of ordering: 566.873.1Y.XX + BE = 566.873.1Y.BE

**Attention:** for the ATEX version of the slip-on connection the code for the connection changes. Example of ordering slip-on connection: 566.873.1Y.TF.EX





# Rotating cleaning nozzle “MiniWhirly” Series 500.186

## Series 500.186

The MiniWhirly made from POM is the economical choice for tank cleaning. The rotating nozzle has effective flat fan nozzles and was specifically designed for applications in barrel and canister cleaning.



**Materials**  
POM,  
316 SS

**Max. temperature**  
122°F/ 50°C

**Recommended operating pressure**  
30 psi

**Installation**  
Vertically facing downward

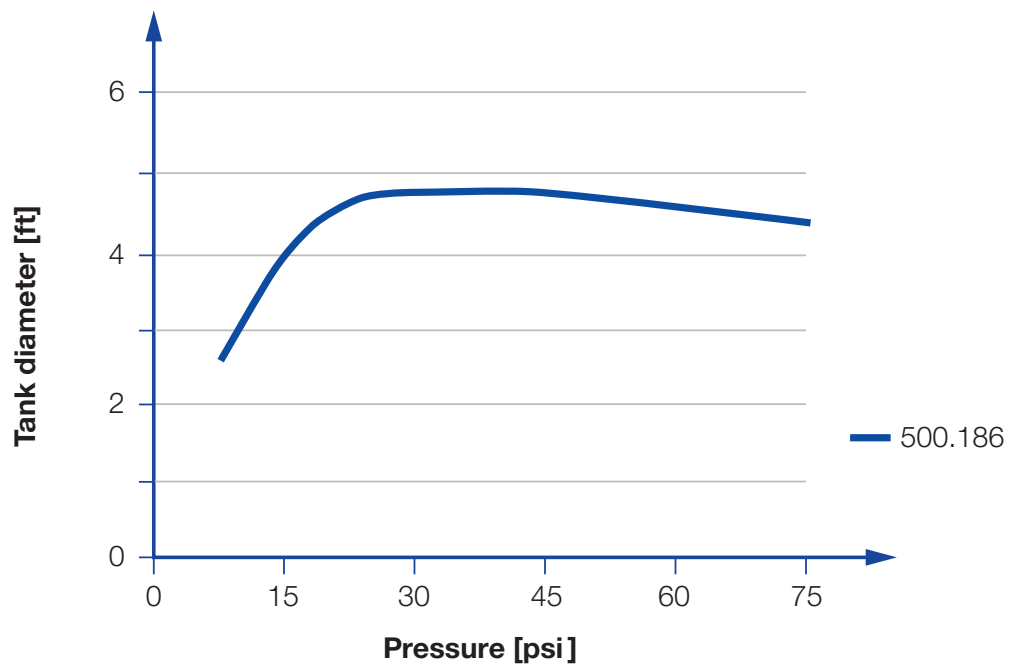

**Filtration**  
Line strainer with a mesh size of 0.3 mm/50 mesh

**Bearing**  
Ball bearing made of stainless steel

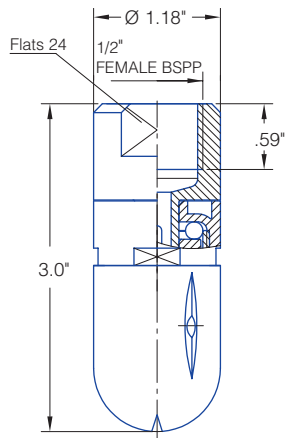

Overview of the tank diameter, depending upon the pressure of series 500.186



Spray angle 	Ordering no.	Free Passage (in.)	Flow Rate (Gallons Per Minute)					Max. tank diameter [ft]
			20 psi	30 psi	liters per minute 2 bar	40 psi	60 psi	
300° 	<b>500. 186. 56. AH</b>	.075	4.0	4.8	18	5.6	6.8	4.3

The maximum tank diameter shown above applies for the recommended operating pressure and is indicative only. The cleaning result is also affected by the type of soiling.

### Information on operation

- Operation with compressed air purge only for short-term usage. Operation above the recommended operating pressure means higher wear and smaller droplets. This might have adverse effects on the cleaning result.



# Rotating cleaning nozzle »NanoSpinner 2« Series 5M1

**NEW**

## Series 5M1

The NanoSpinner 2 has a compact design which allows cleaning in confined spaces. The rotating cleaning nozzle is characterized by its popular design and a double ball bearing. It is made entirely of stainless steel and is suitable for high ambient temperatures.



	<b>Max. tank diameter [ft]</b>	0	1	2	3	4	5	6	7	8	9
--	--------------------------------	---	---	---	---	---	---	---	---	---	---

**Materials**  
Stainless steel 316L

**Max. temperature**  
482°F/ 250°C

**Recommended operating pressure**  
30 psi

**Installation**  
Operation in every direction is possible

**Filtration**  
Line strainer with a mesh size of 0.1 mm/170 Mesh

**Bearing**  
Double ball bearing made of stainless steel 316L

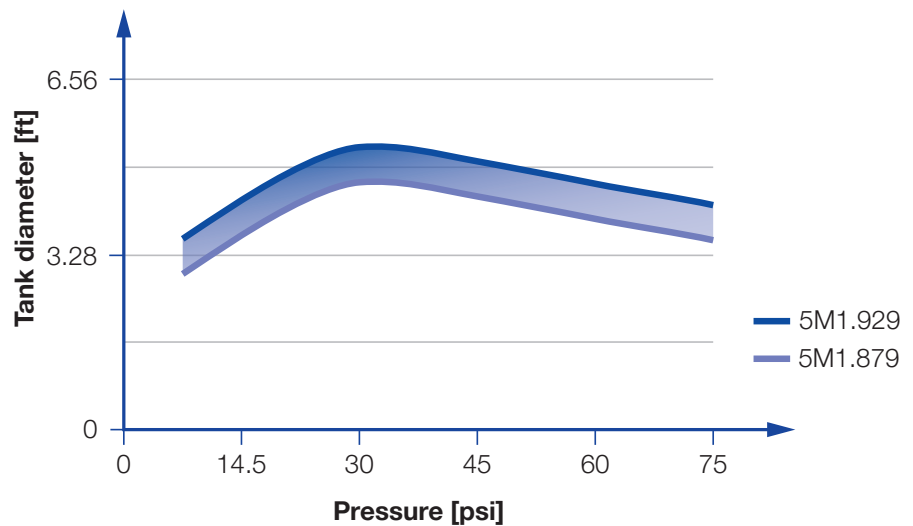

Overview of the tank diameter, depending upon the pressure of series 5M1







# Rotating cleaning nozzle »MicroSpinner 2« Series 5M2

**NEW**

## Series 5M2

The MicroSpinner 2 has a compact design which allows cleaning in confined spaces. The MicroSpinner 2 is made entirely of stainless steel and designed for use at high temperatures. It is available with many different flow rates and spray angles.

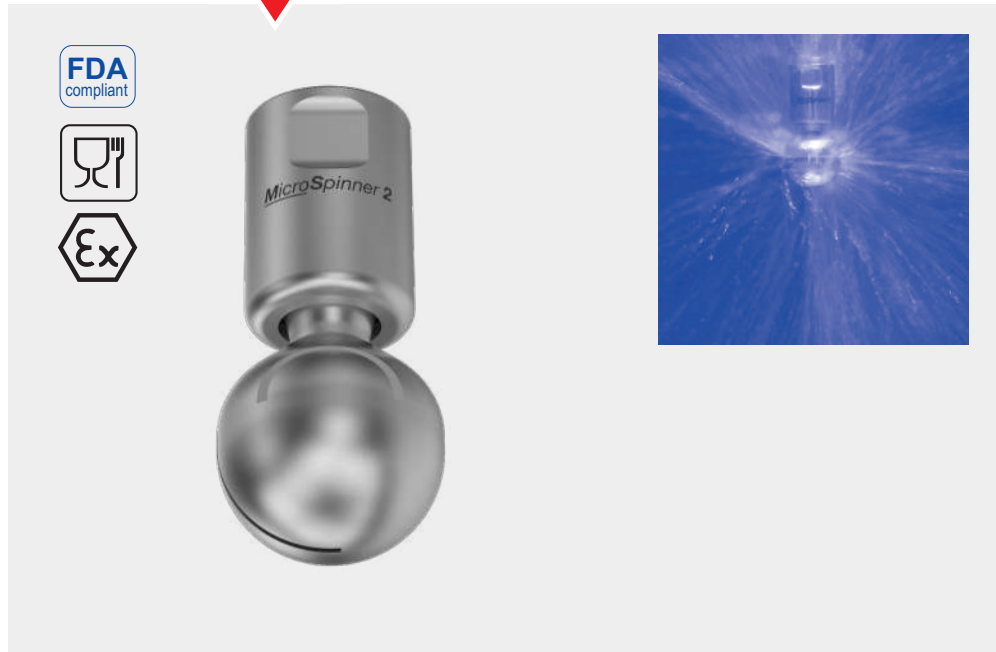

**Materials**  
Stainless steel 316L

**Max. temperature**  
482°F/ 250°C

**Recommended operating pressure**  
30 psi

**Installation**  
Operation in every direction is possible

**Filtration**  
Line strainer with a mesh size of 0.1 mm/170 Mesh

**Bearing**  
Double ball bearing made of stainless steel 316L

**Adapter**  
3/8 BSPP is compatible with HygienicFit

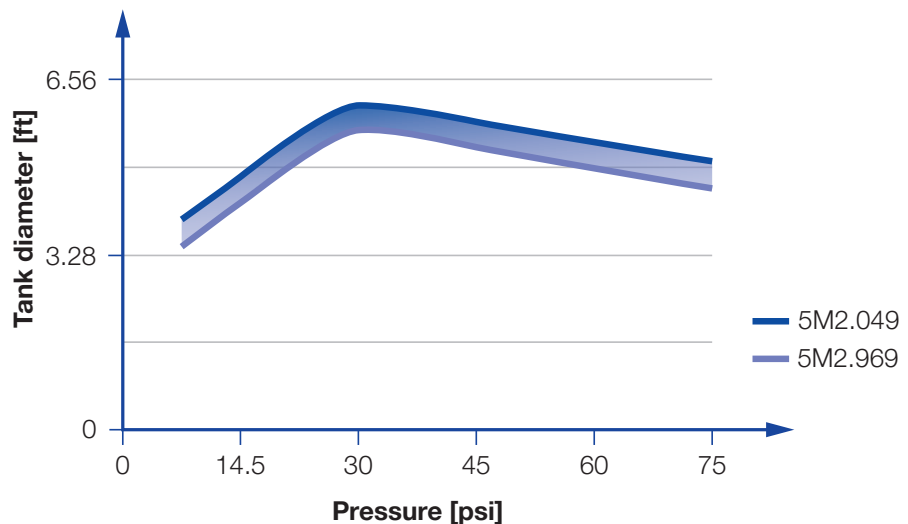

Overview of the tank diameter, depending upon the pressure of series 5M2

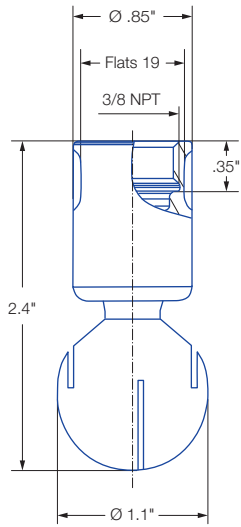



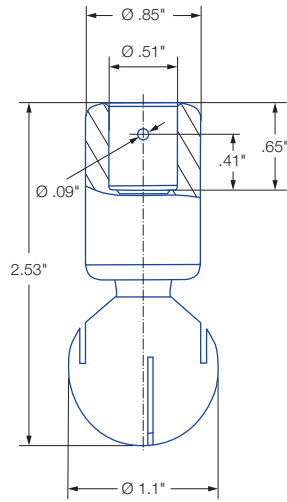

Female thread

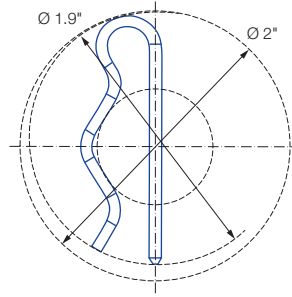

1/2" Slip-on connection  
Dimensions slip-on connection  
according to ASME-BPE (OD-tube)



Dimensions  
slip-on connection  
top view

Spray angle 	Ordering number			E Ø [in]	V̇ [gal/min]				Max. tank diameter [ft]
	Type	Connection			p [psi] (p <sub>max</sub> = 100 psi)				
		3/8 NPT	1/2" Slip-on		20 psi	30 psi	2 bar	40 psi	
60° 	5M2.952.1Y	BF	TF05	.06	5.0	6.2	23	7.1	-
	5M2.042.1Y	BF	TF05	.12	8.8	10.8	40	12.4	-
180° 	5M2.004.1Y	BF	TF05	.04	7.0	8.6	32	9.9	5.9
360° 	5M2.969.1Y	BF	TF05	.03	5.6	6.8	25	7.9	5.6
	5M2.049.1Y	BF	TF05	.04	8.6	10.5	39	12.2	5.9

E = narrowest free cross-section  
Slip-on connection and weld-on versions on request

\*This product is also available in Hastelloy C22

The maximum tank diameter shown above applies for the recommended operating pressure and is indicative only. The cleaning result is also affected by the type of soiling.



### Information on operation



- Operation with compressed air only for short-term usage. Operation above the recommended operating pressure means higher wear and smaller droplets. This might have adverse effects on the cleaning result.

### Slip-on information

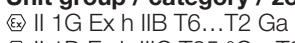
- Split pin made of 316L SS is included. (Ordering no. 05M.230.1Y.00.00.0).
- Depending on diameter of the adapter the flow rate can increase due to leakage between connecting pipe and rotating cleaning nozzle.
- Minimum insertion diameter (with mounted split pin) is 48,5 mm.



**Example of ordering with ATEX approval. FDA and (EG) 1935/2004 conform.**  
Only material 316L SS available with ATEX approval.

**Unit group / category / zones:**  
  

**Example of ordering:** Type + Mat. no. + Connection = Ordering no.  
 5M2.952 + 1Y + BF = 5M2.952.1Y.AF.EX

**Example of ordering with FDA and (EC) 1935/2004 conformity.**

**All Materials are suitable for contact with food.**

**Example of ordering:** Type + Connection = Ordering no.  
 5M2.952.1Y + BF = 5M2.952.1Y.AF

**Attention:** for the ATEX version of the slip-connection the code for the connection changes. Ordering example for connection: 5M2.042.1Y.T1.EX



# Rotating cleaning nozzle »MiniSpinner 2« Series 5M3

**NEW**

## Series 5M3

The MiniSpinner 2 has a popular design for effective cleaning. The MiniSpinner 2 is made of stainless steel and designed for use at high temperatures. It is available with many different flow rates and spray angles.



**Materials**  
Stainless steel 316L

**Max. temperature**  
482°F/ 250°C

**Recommended operating pressure**  
30 psi

**Installation**  
Operation in every direction is possible

**Filtration**  
Line strainer with a mesh size of 0.1 mm/170 Mesh

**Bearing**  
Double ball bearing made of stainless steel 316L

**Adapter**  
1/2 BSPP and 3/4 BSPP are compatible with HygienicFit

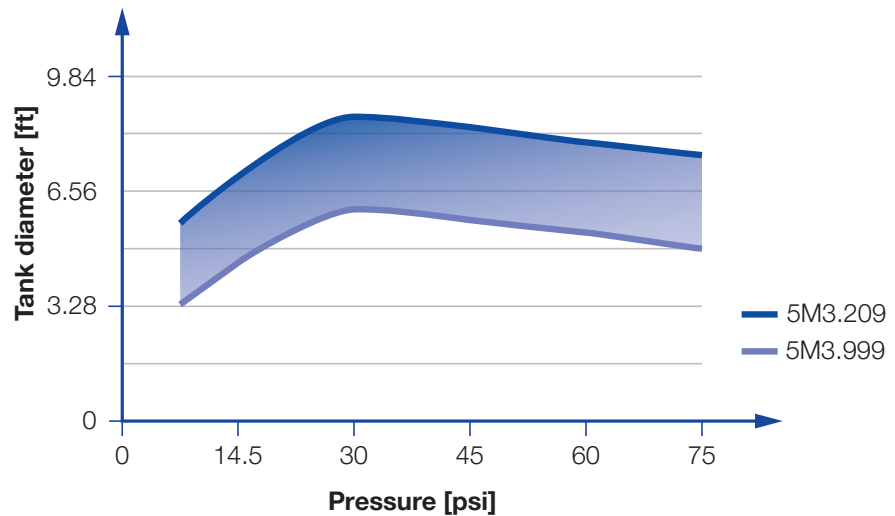

Overview of the tank diameter, depending upon the pressure of series 5M3

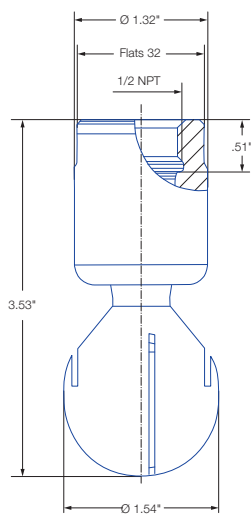

Female thread

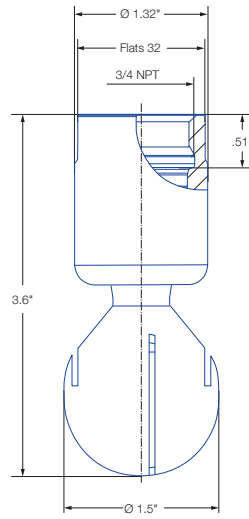



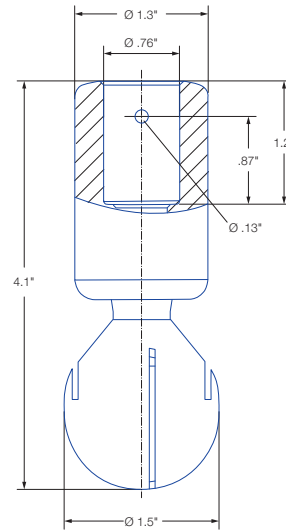

Female thread

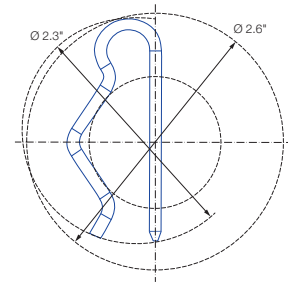

3/4" Slip-on connection  
Dimensions slip-on connection  
according to ASME-BPE (OD-tube)



Dimensions  
slip-on connection  
top view

Spray angle 	Ordering number				E Ø [in]	V̇ [gal/min]				Max. tank diameter [ft]
	Type	Connection				p [psi] (p <sub>max</sub> = 100 psi)				
		1/2 NPT	3/4 NPT	3/4" Slip-on		20 psi	30 psi	2 bar	40 psi	
60° 	5M3.122.1Y	BH	-	TF07	.10	13.8	16.6	63	19.5	-
180° 	5M3.133.1Y	-	BL	TF07	.05	14.7	18.0	67	20.8	8.5
180° 	5M3.134.1Y	-	BL	TF07	.05	14.7	18.0	67	20.8	8.5
360° 	5M3.999.1Y	-	BL	TF07	.02	6.6	8.1	30	9.4	5.9
	5M3.089.1Y	-	BL	TF07	.03	10.8	13.2	49	15.2	6.9
	5M3.139.1Y	-	BL	TF07	.03	15.2	18.7	69	21.5	7.5
	5M3.209.1Y	-	BL	TF07	.06	21.9	26.8	100	30.9	8.5

E = narrowest free cross-section  
NPT, slip-on connection and weld-on versions on request

\*This product is also available in Hastelloy C22

### Information on operation



- Operation with compressed air only for short-term usage. Operation above the recommended operating pressure means higher wear and smaller droplets. This might have adverse effects on the cleaning result.



The maximum tank diameter shown above applies for the recommended operating pressure and is indicative only. The cleaning result is also affected by the type of soiling.

### Slip-on information

- Split pin made of 316L SS is included. (Ordering no.: 05M.330.1Y.00.00.0).
- Depending on diameter of the adapter the flow rate can increase due to leakage between connecting pipe and rotating cleaning nozzle.
- Minimum insertion diameter (with mounted split pin) is 2.32in.

**Example of ordering with ATEX approval. FDA and (EG) 1935/2004 conform.**  
Only material 316L SS available with ATEX approval.



**Unit group / category / zones:**  
 II 1G Ex h IIB T6...T2 Ga  
 II 1D Ex h IIIC T85 °C...T250 °C Da

**Example of ordering:** Type + Mat. no. + Connection = Ordering no.  
 5M3.122 + 1Y + BH = 5M3.122.1Y.BH.EX

**Example of ordering with FDA and (EC) 1935/2004 conformity.**

**All Materials are suitable for contact with food.**

**Example of ordering:** Type + Connection = Ordering no.  
 5M3.122.1Y + BH = 5M3.122.1Y.BH

**Attention:** for the ATEX version of the slip-connection the code for the connection changes. Ordering example for connection: 5M3.122.1Y.T2.EX





# Rotating cleaning nozzle »MaxiSpinner 2« Series 5M4

**NEW**

## Series 5M4

The newly developed MaxiSpinner 2 is similar to the Mini, Micro and NanoSpinner 2 series in many respects. As the largest product of this series, it provides effective cleaning results and a reliable with a durable bearing construction. The MaxiSpinner 2 is made of stainless steel (316L) and is designed for high ambient temperatures.



**Max. tank diameter [ft]**

0 | 2 | 4 | 6 | 8 | 10 | 12 | 14 | 16 | 18



**Materials**  
Stainless steel 316L



**Max. temperature**  
482°F/ 250°C



**Recommended operating pressure**  
30 psi



**Installation**  
Operation in every direction is possible



**Filtration**  
Line strainer with a mesh size of 0.1 mm/170 Mesh



**Bearing**  
Double ball bearing made of stainless steel 316L



**Adapter**  
1 1/4 BSPP and 1 1/2 BSPP are compatible with HygienicFit

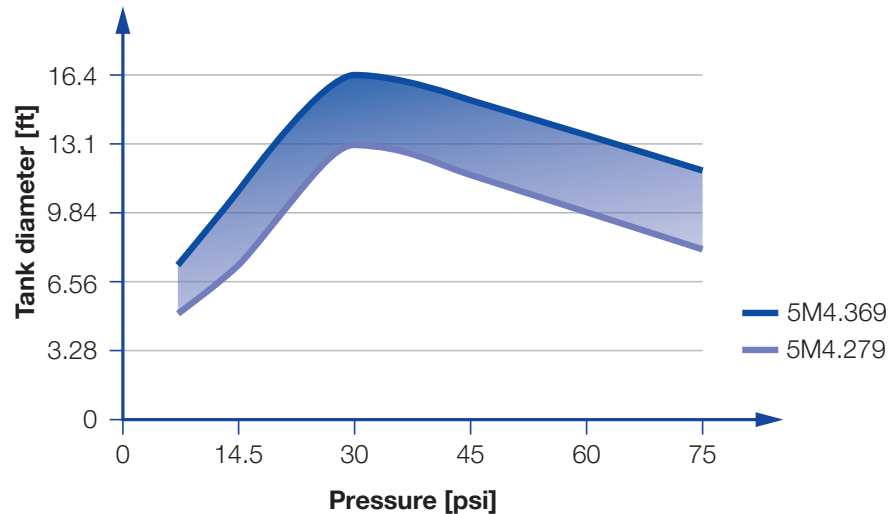

Overview of the tank diameter, depending upon the pressure of series 5M4



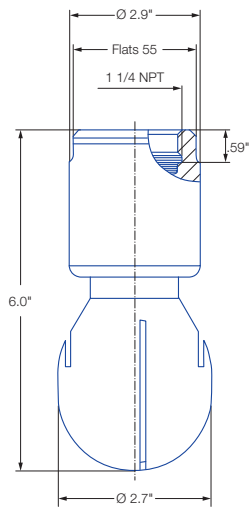

Female thread

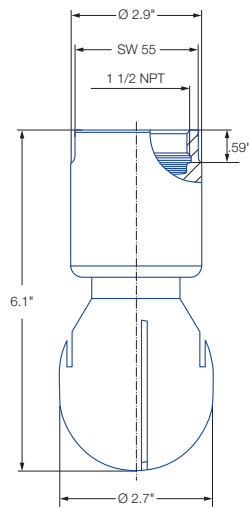

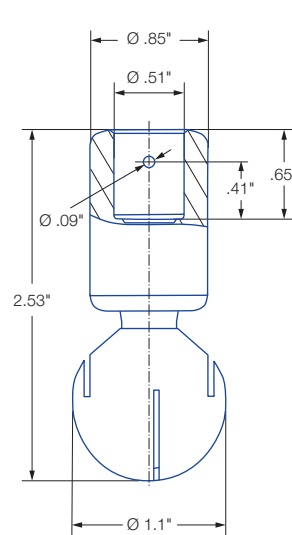

Female thread

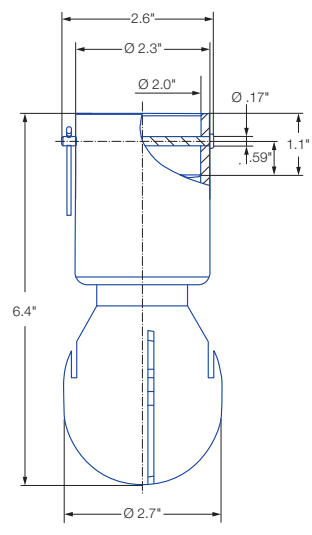

1 1/2" slip-on connection  
Dimensions slip-on connection  
according to ASME-BPE (OD-tube)



2" slip-on connection  
Dimensions slip-on connection  
according to ASME-BPE (OD-tube)

Spray angle 	Ordering number					E ∅ [in]	V̇ [gal/min]				Max. tank diameter [ft]
	Type	Connection					p [psi] (p <sub>max</sub> = 100 psi)*				
		1 1/4 NPT	1 1/2 NPT	1 1/2" Slip-on	2" Slip-on		20 psi	30 psi	2 bar	40 psi	
360° 	5M4.279.1Y	BQ	BS	TF15	TF20	.07	33.0	40.4	150	46.6	13.1
	5M4.329.1Y	BQ	BS	TF15	TF20	.08	43.9	53.8	200	62.1	14.8
	5M4.369.1Y	BQ	BS	TF15	TF20	.09	54.8	67.2	250	77.5	16.4

E = narrowest free cross-section  
Weld-on versions on request

\* Please note the maximum operating pressure of 60 psi for the 2" slip-on version (TF.20).

\*This product is also available in Hastelloy C22

The maximum tank diameter shown above applies for the recommended operating pressure and is indicative only. The cleaning result is also affected by the type of soiling.



### Information on operation



- Operation with compressed air only for short-term usage. Operation above the recommended operating pressure means higher wear and smaller droplets. This might have adverse effects on the cleaning result.

### Slip-on information

- Bolt with head incl. pin made of stainless steel 316L included. (Ordering no. 05M.431.1Y.00.00.0)
- Depending on diameter of the adapter the flow rate can increase due to leakage between connecting pipe and rotating cleaning nozzle.
- Minimum insertion diameter (with mounted bolt) is the same as for the threaded variants 2.72in.

**Example of ordering with ATEX approval. FDA and (EG) 1935/2004 conform.**  
Only material 316L SS available with ATEX approval.



**Unit group / category / zones:**  
 II 1G Ex h IIB T6...T2 Ga  
 II 1D Ex h IIIC T85 °C...T250 °C Da

Example of ordering:	Type	+ Mat. no.	+ Connection	= Ordering no.
	5M4.369 + 1Y	+ BQ		= 5M4.369.1Y.BQ.EX

**Example of ordering with FDA and (EC) 1935/2004 conformity.**

**All Materials are suitable for contact with food.**

Example of Ordering:	Type	+ Connection	= Ordering no.
	5M4.369.1Y	+ BQ	= 5M4.369.1Y.BQ

**Attention:** for the ATEX version of the 1 1/2" slip-connection and the 2" slip-connection the code for the connection changes. Ordering example for 1 1/2" connection: 5M4.369.1Y.T5.EX. Ordering example for 2" connection: 5M4.369.1Y.T6.EX.



# Rotating cleaning nozzles "PTFE Whirly" Series 573 / 583

## Series 573 / 583

The PTFE Whirly is commonly used for applications in the chemical, pharmaceutical and food industries. It works with rotating solid jets and is suitable for use in corrosive environments. The slip-on connection meets 3A standards and is excellent for dairy applications.



**Material**  
PTFE

**Max. temperature**  
203°F/ 95°C  
(Versions for use with higher temperature on request)

**Recommended operating pressure**  
30 psi

**Installation**  
Operates in every direction

**Filtration**  
Line strainer with a mesh size of 0.3 mm/50 Mesh

**Bearing**  
Sleeve bearing made of PTFE

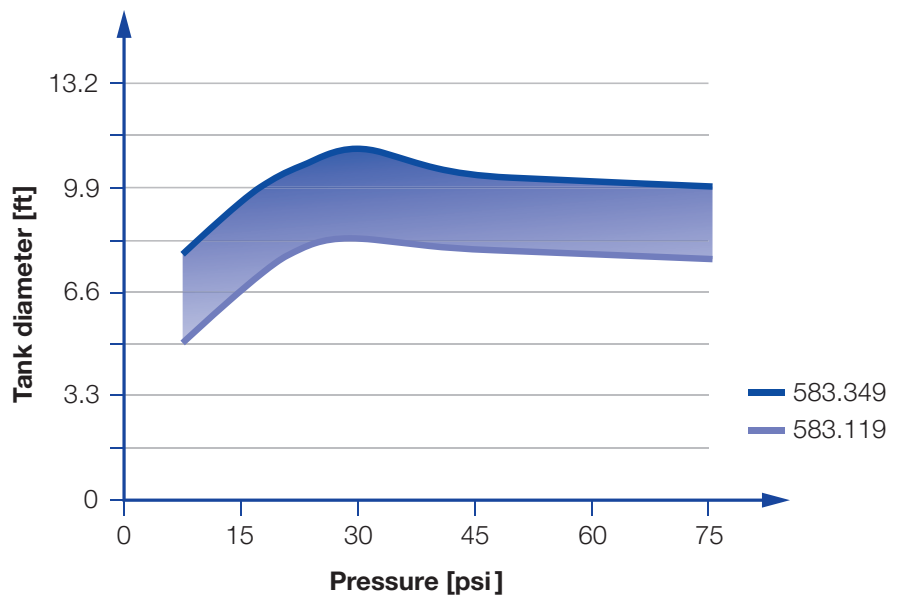

Overview of the tank diameter, depending upon the pressure of series 573 / 583

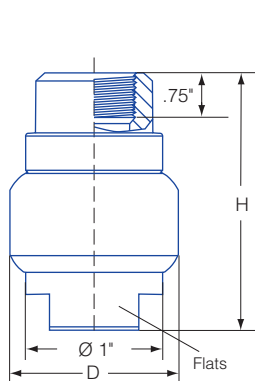



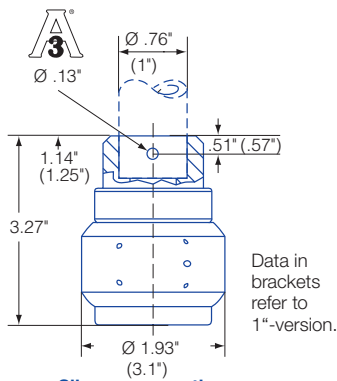

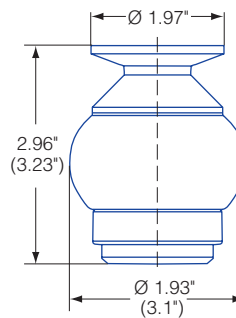

NPT female thread



Slip-on connection for sanitary tube 3-A\*



1 1/2" Tri-Clamp

Spray angle 	R-clip	Ordering no.						Free Passage (in.)	Flow Rate (Gallons Per Minute)					Dimensions for female thread version		Max. tank diameter [ft]
		Type	Connection						20 psi	30 psi	liters per minute	40 psi	60 psi	Height H [in]	Dia-meter D [in]	
			3/4" Female NPT	1" Female NPT	3/4" Slip-on	1" Slip-on	1 1/2" Tri-Clamp									
180° 	1)	583. 114. 55	BL	-	TF07*	-	15	.083	15	18	67	21	26	2.91	1.93	8.2
	1)	583. 264. 55	BL	-	TF07*	-	15	.129	32	39	145	45	55	2.91	1.93	9.2
	2)	583. 344. 55	-	BN	-	-	15	.279	49	60	225	70	85	3.94	3.09	10.5
180° 	1)	573. 114. 55	BL	-	TF07*	-	15	.083	16	18	67	21	26	2.91	1.93	8.2
	1)	573. 264. 55	BL	-	TF07*	-	15	.129	32	39	145	45	55	2.91	1.93	9.2
	2)	573. 344. 55	-	BN	-	-	15	.279	49	60	225	70	85	3.94	3.09	10.5
270° 	1)	583. 116. 55	BL	-	TF07*	-	15	.094	15	18	67	21	26	2.91	1.93	8.2
	1)	583. 266. 55	BL	-	TF07*	-	15	.133	32	39	145	45	55	2.91	1.93	9.2
	2)	583. 346. 55	-	BN	-	-	15	.232	49	60	225	70	85	3.94	3.09	10.5
270° 	1)	573. 116. 55	BL	-	TF07*	-	15	.094	15	18	67	21	26	2.91	1.93	8.2
	1)	573. 266. 55	BL	-	TF07*	-	15	.133	32	39	145	45	55	2.91	1.93	9.2
	2)	573. 346. 55	-	BN	-	-	15	.232	49	60	225	70	85	3.94	3.09	10.5
360° 	1)	583. 119. 55	BL	-	TF07*	-	15	.071	13	16	58	18	22	2.91	1.93	7.9
	1)	583. 209. 55	BL	-	TF07*	-	15	.138	22	27	100	31	38	2.91	1.93	8.2
	1)	583. 269. 55	BL	-	TF07*	-	15	.189	32	39	145	45	55	2.91	1.93	9.2
	2)	583. 279. 55	-	BN	-	TF10*	15	.146	33	40	150	47	57	3.94	3.09	9.8
	2)	583. 349. 55	-	BN	-	TF10*	15	.220	50	61	226	70	86	3.94	3.09	10.5

\* Complies with and is authorized to use with 3-A® symbol.

The maximum tank diameter shown above applies for the recommended operating pressure and is indicative only. The cleaning result is also affected by the type of soiling.

### Information on operation

- Operation with compressed air purge only for short-term usage. Operation above the recommended operating pressure means higher wear and smaller droplets. This might have adverse effects on the cleaning result.

### Slip-on information

- R-clip made of stainless steel AISI 316 L is included (Ordering no.: R-clip 1: 095.022.1Y.50.88.E), R-clip 2: 095.022.1Y.50.60.E).
- Depending on diameter of the adapter the flow rate can increase due to leakage between the connection and rotating cleaning nozzle.

Example of ordering: Type 583. 114. 55. + Connection BL = Ordering no. 583. 114. 55. BL



# Rotating cleaning nozzle “PTFE Hi Temp Whirly” Series 599

## Series 599

While PTFE can withstand high temperatures, its dimensional stability limits its range as a tank cleaning device. Lechler's design incorporates Hastelloy rings to control the expansion of the material so it can continue to operate reliably in hotter environments than normally possible. The nozzle's temperature range is actually extended, since it can perform equally well under normal conditions.



**Max. tank diameter [ft]**



**Material**

PTFE  
Rings: Alloy C-276



**Max. temperature**

274°F/ 134°C



**Recommended operating pressure**

30 psi



**Installation**

Operates in every direction



**Filtration**

Line strainer with a mesh size of 50 Mesh



**Bearing**

Slide bearing

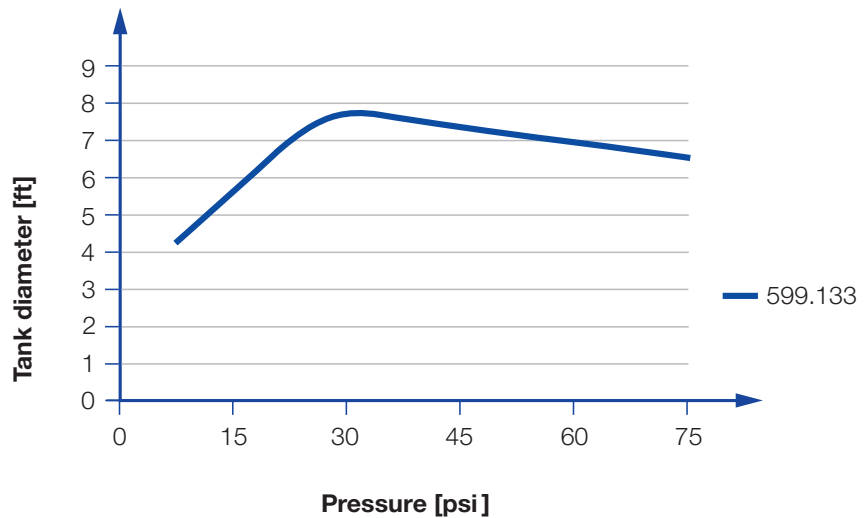

Overview of the tank diameter, depending upon the pressure of series 599

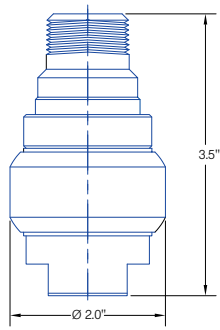

599.133

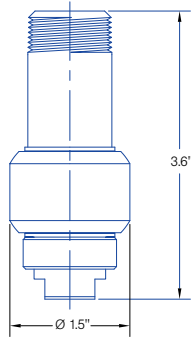

599.170

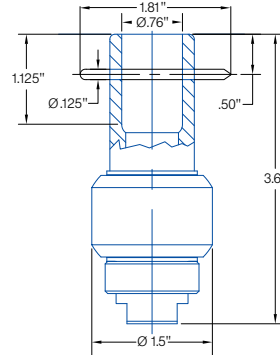

599.174 Female Tube Slip-on

Spray angle	Ordering no.	Connection		Flow Rate (Gallons Per Minute)					Max. tank diameter [ft]
		3/4" Male NPT	3/4" OD Female Slip-on	20 psi	30 psi	liters per minute 2 bar	40 psi	60 psi	
360°	599. 133. 55	BK	-	22	27	100	31	38	8.2
	599. 170. 55	BK	-	19	23	84	26	32	8
	599. 174. J7	-	TF07	19	23	84	26	32	8

The maximum tank diameter shown above applies for the recommended operating pressure and is indicative only. The cleaning result is also affected by the type of soiling.

**Information on operation**

■ We do not recommend operation of these products with compressed air or gases. However, these products have been shown to be suitable for spraying on low pressure steam (refer to Applications above). To protect the products' inner workings when spraying liquid, we suggest use of a line strainer with a 50 mesh size. For further information, please contact Lechler.

<b>Example of ordering:</b>	<b>Type</b>	<b>+</b>	<b>Connection</b>	<b>=</b>	<b>Ordering no.</b>
	599. 133. 55.	+	BK	=	599. 133. 55. BK

**Slip-on information**

- R-clip made of Alloy C-276 is included (Ordering no.: R-clip 1: 095.022.1Y.50.60.E).
- The nozzles with a slip-on connection type fitting may have a higher flow rate than listed due to the self-flushing design around the customer's tube which is inserted into the nozzle socket.

2  
Cleaning efficiency class

3  
Cleaning efficiency class

4  
Cleaning efficiency class

5  
Cleaning efficiency class

Static cleaning nozzles



# Pop-up rotating cleaning nozzles “PopUp Whirly” Series 5P2 / 5P3

**NEW**

## Series 5P2 / 5P3

When a certain fluid pressure is reached, the rotating of the PopUp Whirly is automatically extended from the enclosure. These free-spinning rotating nozzles can be installed flush in the tank wall. They are also suitable for cleaning pipes and for applications that use foam. They are of particular interest for applications in the food and beverage industry as well as for the pharmaceutical and chemical industry.



FDA compliant



	<b>Max. tank diameter [ft]</b>	0	5	10	15	20	25	30
--	--------------------------------	---	---	----	----	----	----	----

**Materials**  
316L SS,  
316Ti SS (spring),  
316 SS (snap ring),  
PEEK (slide-bearing),  
FKM (O-ring)

**Max. temperature**  
284°F / 140°C

**Recommended operating pressure**  
30 psi, 5P2: opening pressure approx. 14.5 psi; closing pressure approx. 7 psi,  
5P3: opening pressure approx. 13 psi, closing pressure approx. 7 psi

**Installation**  
Operates in every direction

**Filtration**  
Line strainer with a mesh size of 0.3 mm/50 Mesh

**Bearing**  
Sleeve bearing made of PEEK

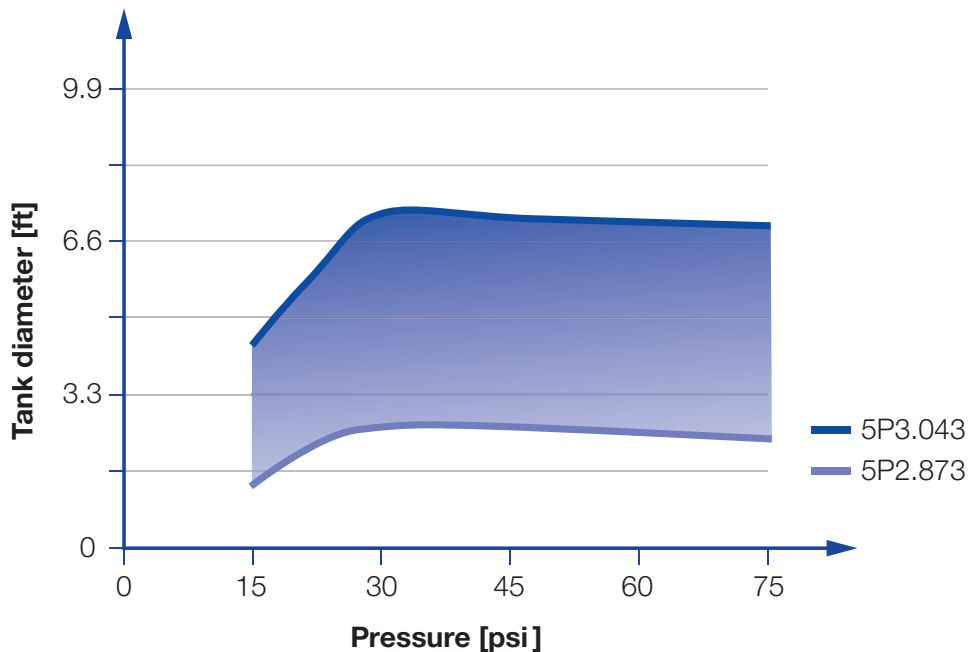

Overview of the tank diameter, depending upon the pressure of series 5P2/5P3



## Series 5P2

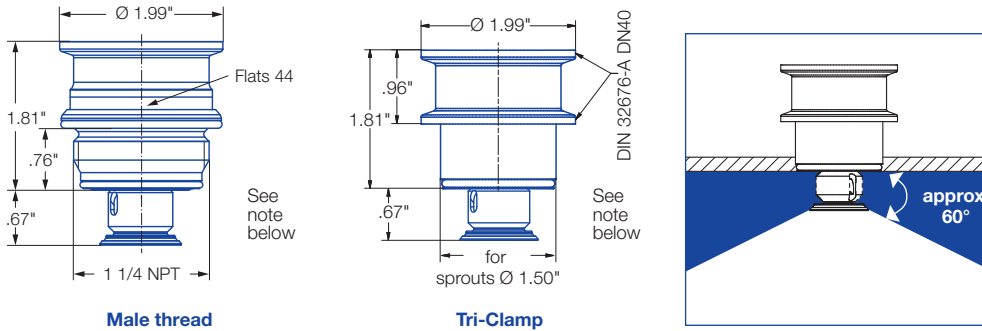

Spray angle	Ordering no.	Tank connection		Free Passage (in.)	Flow Rate (Gallons Per Minute)				Max. tank diameter [ft]
		1 1/4" Male BSPP	Tri Clamp		20 psi	30 psi	liters per minute	40 psi	
	<b>5P2. 873. 1Y. AP</b>	○	-	.04	3.3	4	15.0	4.7	2.6
	<b>5P2. 873. 1Y. 00</b>	-	○	.04	3.3	4	15.0	4.7	2.6
	<b>5P2. 923. 1Y. AP</b>	○	-	.04	4.4	5.4	20.0	6	3.3
	<b>5P2. 923. 1Y. 00</b>	-	○	.04	4.4	5.4	20.0	6	3.3

The maximum tank diameter shown above applies for the recommended operating pressure and is indicative only. The cleaning result is also affected by the type of soiling.

### Nozzle installation

With thread in idle position

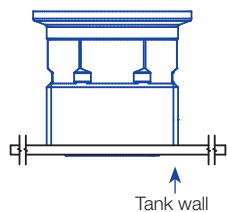

With Tri-Clamp in operating position

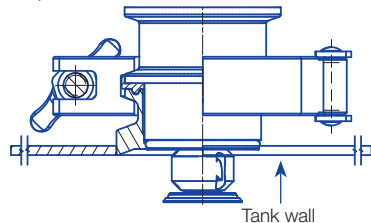

### Information on operation

- The PopUp Whirly is not suitable for operation with compressed air or any other gas.
- Operation above the recommended operating pressure means higher wear and smaller droplets. This might have adverse effects on the cleaning result

### Weld-in flange for Tri-Clamp-Version

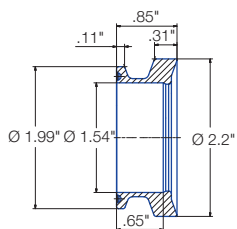

**Ordering number**  
050.020.1Y.01.00

**Material**  
316L SS

#### Information

Gasket with a thickness of .08 in must be used if the nozzle is installed with this weld-in flange. Not sold with nozzle. Use standard DIN32676-A / DN40

### Weld-in socket for Thread-Version

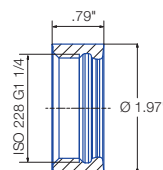

**Ordering number**  
050.020.1Y.AQ.00

**Material**  
316L SS

#### Information

The thread is hygienically sealed with 2 O-rings included in the scope of delivery.



# Pop-up rotating cleaning nozzles "PopUp Whirly" Series 5P2 / 5P3

## Series 5P3

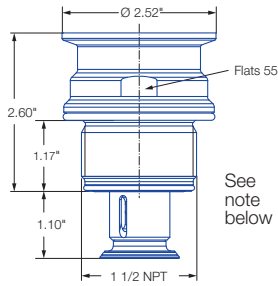

Male thread

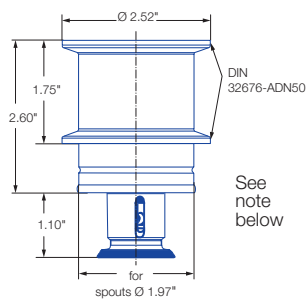

Tri-Clamp

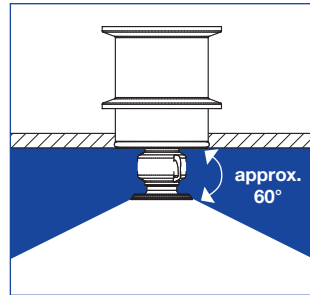

Spray angle	Ordering no.	Tank connection		Free Passage (in.)	Flow Rate (Gallons Per Minute)				Max. tank diameter [ft]
		1 1/2" Male BSSP	Tri Clamp		20 psi	30 psi	liters per minute 2 bar	40 psi	
	<b>5P3. 043. 1Y. AR</b>	○	-	.05	3.3	4	15.0	4.7	7.2
	<b>5P3. 043. 1Y. 00</b>	-	○	.05	3.3	4	15.0	4.7	7.2

The maximum tank diameter shown above applies for the recommended operating pressure and is indicative only. The cleaning result is also affected by the type of soiling.

## Nozzle installation

With thread in idle position

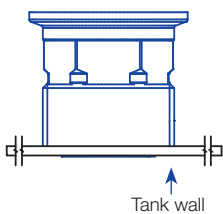

With Tri-Clamp in operating position

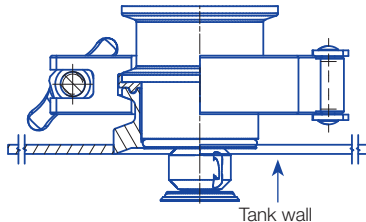

## Information on operation

- The PopUp Whirly is not suitable for operation with compressed air or any other gas.
- Operation above the recommended operating pressure means higher wear and smaller droplets. This might have adverse effects on the cleaning result

## Weld-in flange for Tri-Clamp-Version

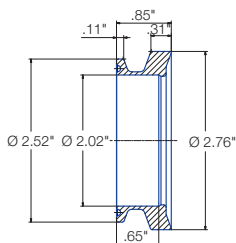

### Ordering number

050.020.1Y.01.01

### Material

316L SS

### Information

Gasket with a thickness of .08 in must be used if the nozzle is installed with this weld-in flange. Not sold with nozzle. Use standard DIN32676-A / DN50

## Weld-in socket for Thread-Version

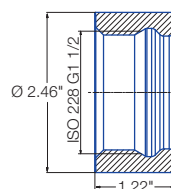

### Ordering number

050.020.1Y.AS.00

### Material

316L SS

### Information

The thread is hygienically sealed with 2 O-rings included in the scope of delivery.





# EFFICIENT REMOVAL OF LIGHT AND MEDIUM SOILING

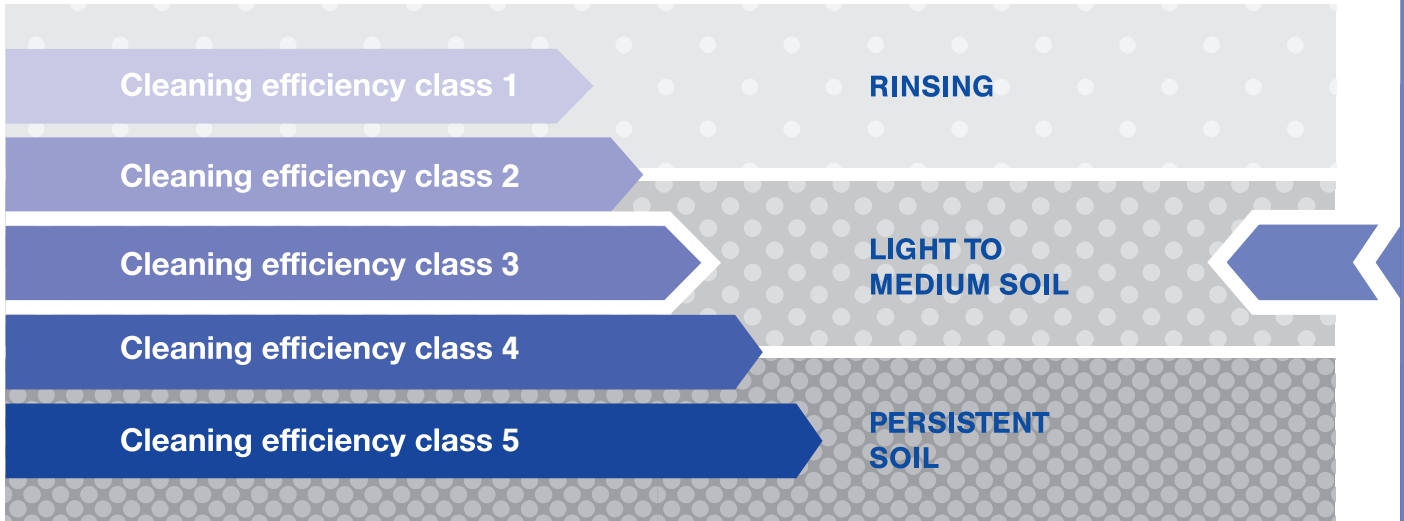

## Cleaning efficiency class 3

Due to their special nozzle geometry and flow rates from 3 to 303 gpm at 30 psi, the rotating nozzles in efficiency class 3 are suitable for cleaning medium soiling from tanks and equipment. Such soiling is especially found in the food and beverage industry, but also in the chemical and pharmaceutical industry. The free-spinning rotating nozzles in Class 3 are made from especially high-grade materials, are available in tank sizes from small to large.

The HygienicWhirly is perfectly suited for hygienically sensitive areas and can also be used for the output of foam.

The Stainless Steel Whirly series is also available as an ATEX version and can therefore also be used in explosive environments.

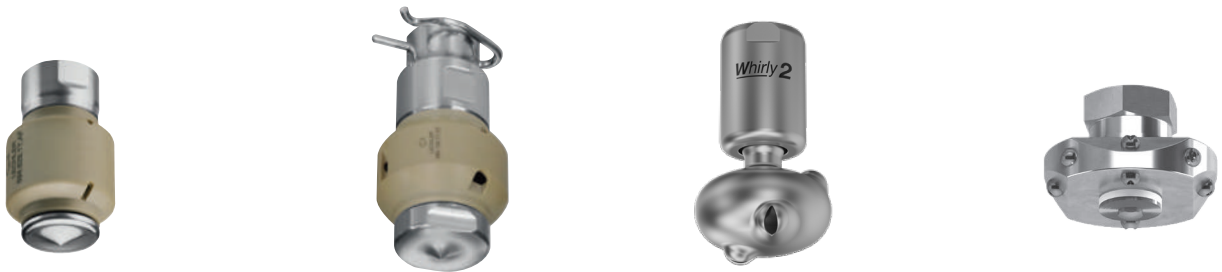

	<b>Max. tank diameter [ft]</b>	0	10	20	30	40
--	--------------------------------	---	----	----	----	----

**Operating principles**  
Free-spinning

**Flow rates at 30 psi**  
3 to 169 gpm

**Recommended operating pressures**  
30 to 40 psi

**Max. temperatures**  
194 to 284°F  
90 to 140°C



# Rotating cleaning nozzles “HygienicWhirly” Series 594 / 595

## Series 594 / 595

The HygienicWhirly is designed for spraying foam and its highly effective flat jets still provide excellent cleaning effects.



**Max. tank diameter [ft]**

0

5

10

15

20

25



### Materials

AISI 316L SS,  
PEEK



### Max. temperature

212°F/ 100°C,  
short-term  
up to 284°F/ 140°C



### Recommended operating pressure

40 psi



### Installation

Operates in every  
direction



### Filtration

Line strainer with  
a mesh size of  
0.3 mm/50 Mesh



### Bearing

Sleeve bearing  
made of PEEK

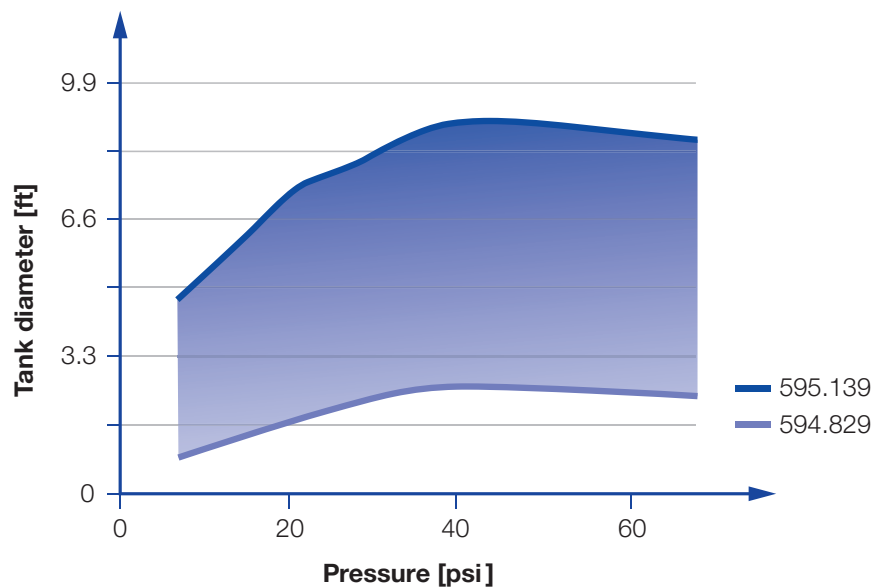

Overview of the tank diameter, depending upon the pressure of series 594 / 595



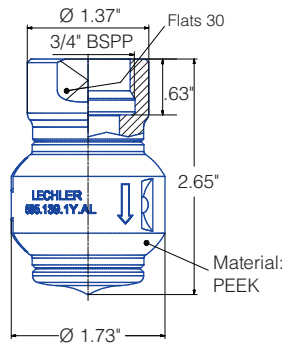

**Standard version  
female thread  
595.139.1Y.AL**

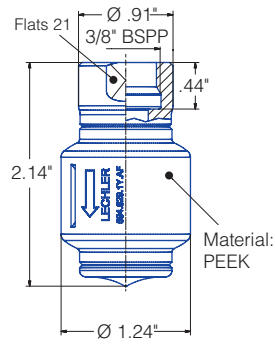

**Standard version  
female thread  
594.XX9.1Y.AF**

Spray angle	Ordering no.			Free Passage (in.)	Flow Rate (Gallons Per Minute)					Max. tank diameter [ft]
	Type	Connection			7 psi	15 psi	liters per minute 2 bar	30 psi	40 psi	
		3/8" Female BSPP	3/4" Female BSPP							
360°	594. 829. 1Y	AF	-	.067	1.4	2.1	11	3.0	3.4	3
	594. 879. 1Y	AF	-	.098	1.9	2.9	15	4.0	4.7	4
	595. 009. 1Y	AF	-	.157	4.2	6.1	32	8.6	9.8	5
	595. 049. 1Y	AF	-	.165	5.2	7.6	40	10.7	12.4	7
	595. 139. 1Y	-	AL	.197	8.7	12.7	67	18.0	20.8	9

The maximum tank diameter shown above applies for the recommended operating pressure and is indicative only. The cleaning result is also affected by the type of soiling.

### Information on operation

- Operation with compressed air purge only for short-term usage. Operation above the recommended operating pressure means higher wear and smaller droplets. This might have adverse effects on the cleaning result.

**Example of ordering:** Type 594. 829. 1Y + Connection AF = Ordering no. 594. 829. 1Y. AF

### Slip-on information

- R-clip made of stainless steel AISI 316L is included (Ordering no.: 095.022.1Y.50.94.E).
- Depending on diameter of the adapter the flow rate can increase due to leakage between the connection and rotating cleaning nozzle.



# Rotating cleaning nozzle "Whirly 2" Series 5W9

## Series 5W9

The Whirly 2 has a hygienic design, and provides efficient cleaning due to its powerful flat jet sprays. Also available in ATEX approved version.



	<b>Max. tank diameter [ft]</b>	0	5	10	15	20	25
--	--------------------------------	---	---	----	----	----	----

**Materials**  
Stainless steel  
316L, PEEK

**Max. temperature**  
284°F/ 140°C  
194°F/ 90°C ATEX version

**Recommended operating pressure**  
30 psi

**Installation**  
Operates in every direction. is possible

**Filtration**  
Line strainer with a mesh size of 0.1 mm/ 170 Mesh

**Bearing**  
Double ball bearing made of stainless steel

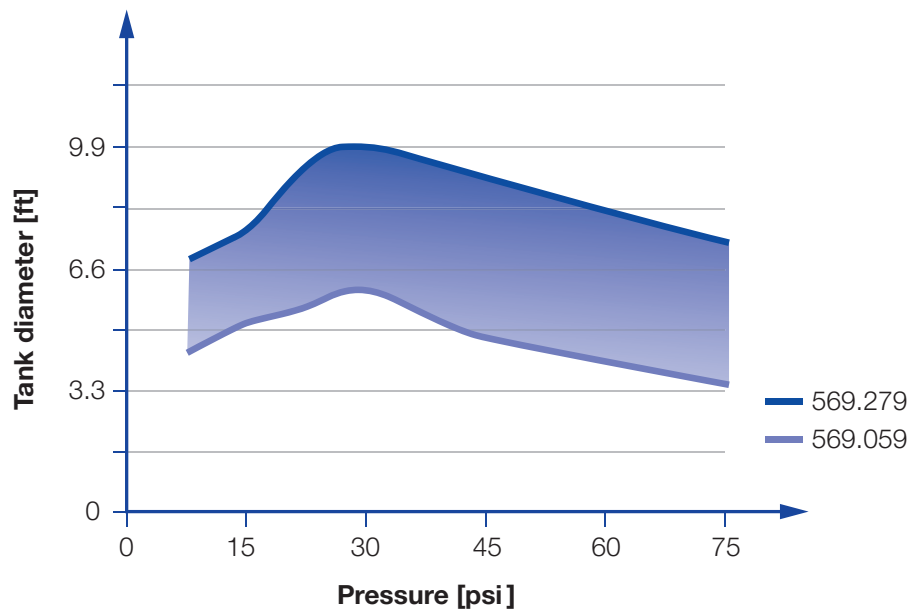

Overview of the tank diameter, depending upon the pressure of series 569

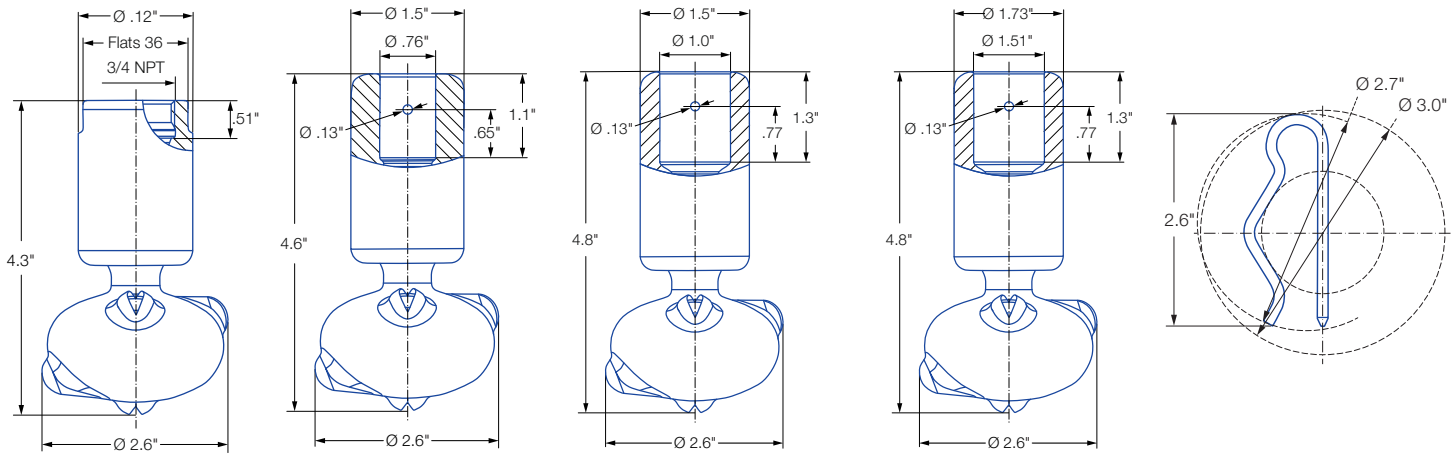

**Female thread**      **Dimensions slip-on connection according to ASME-BPE (OD-tube)**      **Dimensions slip-on connection according to ASME-BPE (OD-tube)**      **Dimensions slip-on connection according to ASME-BPE (OD-tube)**      **Dimensions slip-on connection top-view**

Spray angle	Type	Ordering no. Connection				Narrowest free cross section Ø [in]	V water [gal/min]					Max. tank diameter [ft]
		3/4 NPT	3/4"- Slip-on connection	1" Slip-on connection	1.5" Slip-on connection		p [psi] (p <sub>max</sub> = 87 psi)					
							20 psi	30 psi	2 bar	40 psi	60 psi	
270° 	5W9.075.1Y	BL	TF07	TF10	TF15	.79	10.6	12.9	48	15	18.3	5.9
	5W9.145.1Y	BL	TF07	TF10	TF15	.11	15.6	19.1	71	22	27.0	6.9
	5W9.195.1Y	BL	TF07	TF10	TF15	.13	21.3	26.1	97	30	36.9	8.5
270° 	5W9.076.1Y	BL	TF07	TF10	TF15	.79	10.6	12.9	48	15	18.3	5.9
	5W9.106.1Y	BL	TF07	TF10	TF15	1.0	12.8	15.6	58	18	22.0	6.9
	5W9.196.1Y	BL	TF07	TF10	TF15	1.3	21.3	26.1	97	30	36.9	8.5
360° 	5W9.079.1Y	BL	TF07	TF10	TF15	.06	10.6	12.9	48	15	18.3	5.9
	5W9.149.1Y	BL	TF07	TF10	TF15	.09	15.6	19.1	71	22	27.0	6.9
	5W9.199.1Y	BL	TF07	TF10	TF15	.12	21.3	26.1	97	30	36.9	8.5
	5W9.279.1Y	BL	TF07	TF10	TF15	.20	31.9	39.1	145	45	55.2	9.8

The maximum tank diameter shown above applies for the recommended operating pressure and is indicative only. The cleaning result is also affected by the type of soiling.

### Information on operation

- Operation with compressed air purge only for short-term usage. Operation above the recommended operating pressure means higher wear and smaller droplets. This might have adverse effects on the cleaning result.

### Slip-on information

- R-clip made of stainless steel AISI 316L is included (Ordering no.: 095.022.1Y.50.60.E).
- Depending on diameter of the adapter the flow rate can increase due to leakage between the connection and rotating cleaning nozzle.

**Example of ordering with ATEX approval. FDA and (EG) 1935/2004 conform.**

**Unit group / category / zones:**  
 II 1G Ex h LLB T6... T3 Ga  
 II 1D Ex h IIIC T85 °C...T150 °C Da

**Example    Type                    +    Connection    =    Ordering no.**  
**of Ordering: 569.055.1Y.XX.EX + BL                    = 569.055.1Y.BL.EX**

**Example of ordering with FDA and (EG) 1935/2004 conform.**

**All Materials are suitable for contact with food.**

**Example    Type                    +    Connection    =    Ordering no.**  
**of ordering: 569.103.1Y.XX + BL                    = 569.103.1Y.BL**



# Rotating cleaning nozzles "Gyro" Series 577

## Series 577

The Gyro cleans with powerful nozzle inserts and is the largest capacity free spinning design. The Gyro is capable of cleaning very large tanks and is clog-resistant.



**Materials**  
316 SS, PTFE

**Max. temperature**  
194°F/ 90°C

**Recommended operating pressure**  
40 psi

**Installation**  
Vertically facing downward

**Filtration**  
Line strainer with a mesh size of 0.3 mm/50 mesh



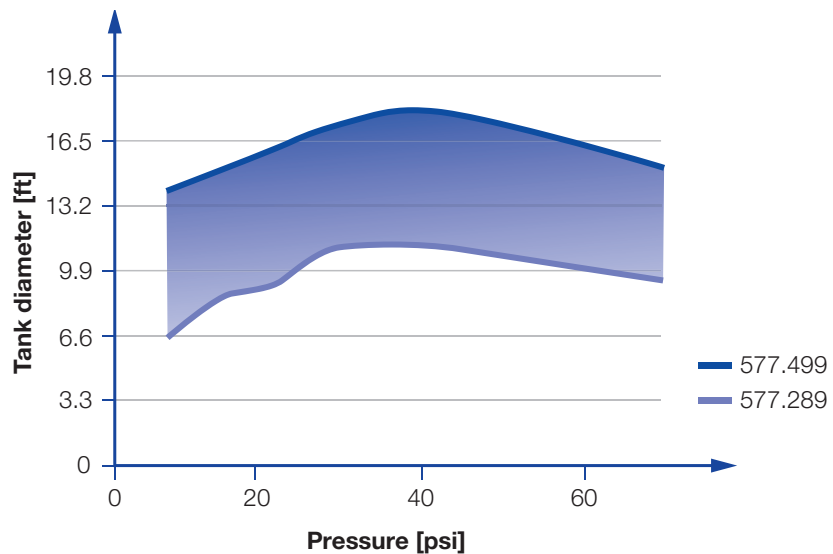

**Bearing**  
Slide bearing made of PTFE

**Accessories**  
Spare parts set consisting of: top seal, bottom seal and complete instructions.

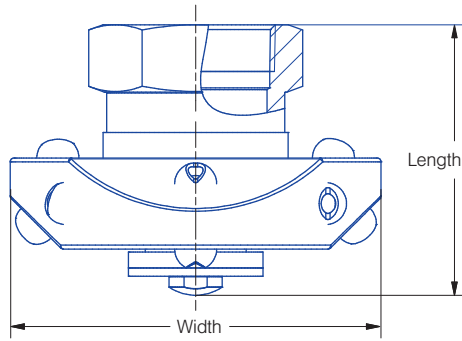

Overview of the tank diameter, depending upon the pressure of series 577



Spray angle 	Ordering no.			Flow Rate (Gallons Per Minute)				Dimensions		Max. tank diameter [ft]
	Type	Connection		20 psi	liters per minute 2 bar	40 psi	60 psi	Length (in.)	Width (in.)	
		1" NPT	2" NPT							
180° 	577. 283. 1Y	BN	-	36	163	51	62	2.8	4.6	11.2
	577. 363. 1Y	BN	-	57	258	80	98	2.8	4.6	12.5
	577. 403. 1Y	-	BW	71	322	100	122	4.1	6.1	14.4
	577. 433. 1Y	-	BW	85	386	120	147	4.1	6.1	16.4
	577. 523. 1Y	-	BW	140	639	199	243	4.1	6.1	18
180° 	577. 284. 1Y	BN	-	36	161	51	62	2.8	4.6	11.2
	577. 364. 1Y	BN	-	57	258	80	98	2.8	4.6	12.5
	577. 404. 1Y	-	BW	71	322	100	122	4.1	6.1	14.4
	577. 434. 1Y	-	BW	85	386	120	147	4.1	6.1	16.4
	577. 494. 1Y	-	BW	145	538	167	205	4.1	6.1	18
270° 	577. 285. 1Y	BN	-	36	161	51	62	2.8	4.6	11.2
	577. 365. 1Y	BN	-	57	258	80	98	2.8	4.6	12.5
	577. 405. 1Y	-	BW	71	322	100	122	4.1	6.1	14.4
	577. 435. 1Y	-	BW	85	386	120	147	4.1	6.1	16.4
	577. 495. 1Y	-	BW	145	538	167	205	4.1	6.1	18
360° 	577. 289. 1Y	BN	-	36	161	51	62	2.8	4.6	11.2
	577. 369. 1Y	BN	-	57	258	80	98	2.8	4.6	12.5
	577. 409. 1Y	-	BW	71	322	100	122	4.1	6.1	14.4
	577. 439. 1Y	-	BW	85	386	120	147	4.1	6.1	16.4
	577. 499. 1Y	-	BW	145	538	167	205	4.1	6.1	18

### Information on operation

- Operation with compressed air purge only for short-term usage. Operation above the recommended operating pressure means higher wear and smaller droplets. This might have adverse effects on the cleaning result.

The maximum tank diameter shown above applies for the recommended operating pressure and is indicative only. The cleaning result is also affected by the type of soiling.

**Example**      **Type**      +      **Connection**      =      **Ordering no.**  
**for Ordering:**    577. 283. 1Y. +    BN      =    577. 283. 1Y. BN



# EFFECTIVE REMOVAL OF HEAVY SOILING

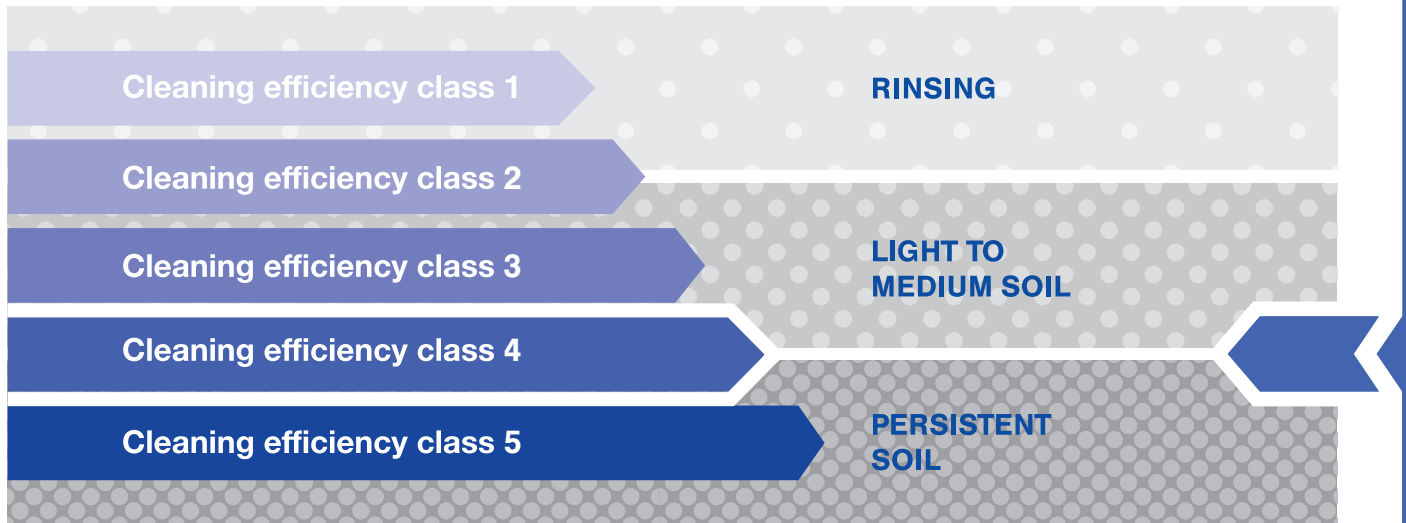

## Cleaning efficiency class 4

The Lechler products in this class use controlled rotation. They are suitable for contact with food, the cleaning of large tanks and for use in combination with the Lechler rotation monitoring sensor. The cleaning nozzles of Class 4 are available in many different sizes and flow rates.

The flat spray nozzle design of the rotating cleaners in class 4 ensure the removal of heavy soiling at temperatures of up to 284°F / 140°C.



	<b>Max. tank diameter [ft]</b>	0	5	10	15	20	25	30
---	--------------------------------	---	---	----	----	----	----	----

 **Operating principles**  
Controlled rotation

 **Flow rates at 30 psi**  
6 to 79 gpm

 **Recommended operating pressures**  
40 to 75 psi

 **Max. temperatures**  
203 to 284°F  
95 to 140°C





# Rotating cleaning nozzle “XactClean® HP” Series 5S2 / 5S3

## Series 5S2 / 5S3

Specially developed flat fan nozzles provide high impact and uniform cleaning for the XactClean® HP. The controlled rotation ensures that the XactClean® HP works extremely efficient. Thanks to the robust drive unit the XactClean® HP is very reliable and ensures increased operation reliability. It is available in various spray angles and flow rates and is also compatible with the Lechler rotating monitoring sensor.



**Max. tank diameter [ft]**



**Materials**  
316L SS, 316 SS, 632 SS, PEEK, PEEK ESD (ATEX version only), PTFE, Zirconium oxide, EPDM



**Max. temperature**  
203°F / 95°C



**Recommended operating pressure**  
75 psi



**Installation**  
Operates in every direction



**Filtration**  
Line strainer with a mesh size of 0.3 mm/50 mesh



**Bearing**  
Double ball bearing



**Rotation monitoring sensor**  
Sensor compatible, Info: see page 64

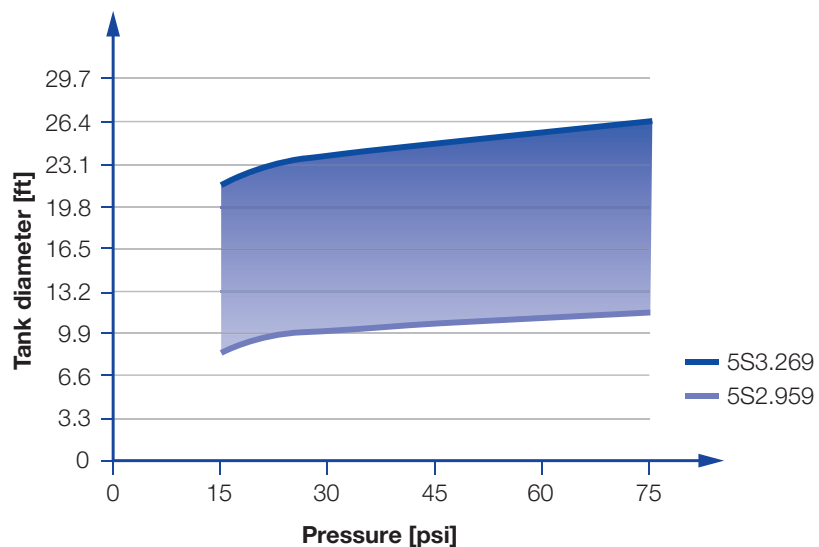

Overview of the tank diameter, depending upon the pressure of series 5S2 / 5S3

## Nozzle dimensions [in]

Connection	H
<b>BF</b>	5.83
<b>BH</b>	5.87
<b>BL</b>	5.47
<b>BN</b>	5.47
<b>TF05 (T5)</b>	5.91
<b>TF07 (T7)</b>	6.46

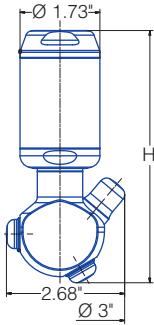

Female thread

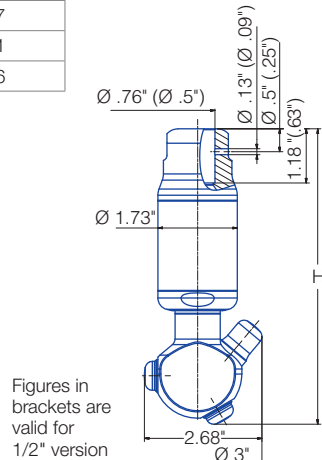

Figures in brackets are valid for 1/2" version

Slip-on connection  
ASME - BPE 1997 (OD-Tube)

## Example of ordering with ATEX approval.

### Unit group / category / zones:

⊕ II 1G Ex h LLB T6... T3 Ga  
⊕ II 1D Ex h IIIC T85 °C...T150 °C Da



Example Type + Connection = Ordering no.  
of ordering: 5S2.955.1Y.XX.EX + BF = 5S2.955.1Y.BF.EX

**Attention:** For the ATEX version of the slip-on-connection, the code for the connection changes.

1/2" slip-on: T5 3/4" slip-on: T7

**Example of ordering slip-on connection:**  
**5S2.955.1Y.T5.EX**

## Example of ordering with FDA and (EG) 1935/2004 conform.



All Materials are suitable for contact with food.



Example Type + Connection = Ordering no.  
of ordering: 5S2.955.1Y.XX + BF = 5S2.955.1Y.BF

Spray angle	Ordering no.							Free Passage Ø (in.)	Flow Rate (Gallons Per Minute)					Max. tank diameter [ft]
	Type	Connection							liters per minute	30 psi	40 psi	75 psi	145 psi	
		3/8" Female NPT	1/2" Female NPT	3/4" Female NPT	1" Female NPT	1/2" OD Slip-on	3/4" OD Slip-on							
180°	5S2.953.1Y	BF	BH	-	-	TF05 (T5)	-	.08	25	6.6	7.8	10.6	15.1	11.5
	5S3.053.1Y	-	BH	-	-	-	TF07 (T7)	.08	41	10.8	12.8	17.2	24.3	13
	5S3.113.1Y	-	BH	BL	-	-	TF07 (T7)	.08	60	15.9	18.4	24.8	35.1	20
	5S3.183.1Y	-	-	BL	-	-	TF07 (T7)	.08	89	23.5	27.7	37.3	52.6	23
	5S3.233.1Y	-	-	BL	-	-	TF07 (T7)	.08	111	29.3	34.3	46.2	65.5	25
	5S3.263.1Y	-	-	BL	BN	-	TF07 (T7)	.08	135	35.7	41.8	56.3	79.5	26
180°	5S2.954.1Y	BF	BH	-	-	TF05 (T5)	-	.08	25	6.6	7.8	10.6	15.1	11.5
	5S3.054.1Y	-	BH	-	-	-	TF07 (T7)	.08	41	10.8	12.8	17.2	24.3	13
	5S3.114.1Y	-	BH	BL	-	-	TF07 (T7)	.08	60	15.9	18.4	24.8	35.1	20
	5S3.184.1Y	-	-	BL	-	-	TF07 (T7)	.08	89	23.5	27.7	37.3	52.6	23
	5S3.234.1Y	-	-	BL	-	-	TF07 (T7)	.08	111	29.3	34.3	46.2	65.5	25
	5S3.264.1Y	-	-	BL	BN	-	TF07 (T7)	.08	135	35.7	41.8	56.3	79.5	26
270°	5S2.955.1Y	BF	BH	-	-	TF05 (T5)	-	.08	25	6.6	7.8	10.6	15.1	11.5
	5S3.055.1Y	-	BH	-	-	-	TF07 (T7)	.08	41	10.8	12.8	17.2	24.3	13
	5S3.115.1Y	-	BH	BL	-	-	TF07 (T7)	.08	60	15.9	18.4	24.8	35.1	20
	5S3.185.1Y	-	-	BL	-	-	TF07 (T7)	.08	89	23.5	27.7	37.3	52.6	23
	5S3.235.1Y	-	-	BL	-	-	TF07 (T7)	.08	111	29.3	34.3	46.2	65.5	25
	5S3.265.1Y	-	-	BL	BN	-	TF07 (T7)	.08	135	35.7	41.8	56.3	79.5	26
270°	5S2.956.1Y	BF	BH	-	-	TF05 (T5)	-	.08	25	6.6	7.8	10.6	15.1	11.5
	5S3.056.1Y	-	BH	-	-	-	TF07 (T7)	.08	41	10.8	12.8	17.2	24.3	13
	5S3.116.1Y	-	BH	BL	-	-	TF07 (T7)	.08	60	15.9	18.4	24.8	35.1	20
	5S3.186.1Y	-	-	BL	-	-	TF07 (T7)	.08	89	23.5	27.7	37.3	52.6	23
	5S3.236.1Y	-	-	BL	-	-	TF07 (T7)	.08	111	29.3	34.3	46.2	65.5	25
	5S3.266.1Y	-	-	BL	BN	-	TF07 (T7)	.08	135	35.7	41.8	56.3	79.5	26
360°	5S2.959.1Y	BF	BH	-	-	TF05 (T5)	-	.07	25	6.6	7.8	10.6	15.1	11.5
	5S3.059.1Y	-	BH	-	-	-	TF07 (T7)	.08	41	10.8	12.8	17.2	24.3	13
	5S3.119.1Y	-	BH	BL	-	-	TF07 (T7)	.08	60	15.9	18.4	24.8	35.1	20
	5S3.189.1Y	-	-	BL	-	-	TF07 (T7)	.08	89	23.5	27.7	37.3	52.6	23
	5S3.239.1Y	-	-	BL	-	-	TF07 (T7)	.08	111	29.3	34.3	46.2	65.5	25
	5S3.269.1Y	-	-	BL	BN	-	TF07 (T7)	.08	135	35.7	41.8	56.3	79.5	26

The maximum tank diameter shown here applies for the recommended operating pressure and is indicative only. The cleaning result is also affected by the type of soiling.

### Information on operation

- Operation with compressed air only for short-term usage. Operation above the recommended operating pressure means higher wear and smaller droplets. This might have adverse effects on the cleaning result.

### Slip-on information

- R-clip made of stainless steel AISI 316L is included  
Ordering no.:  
095.022.1Y.50.60.E (TF07),  
095.013.1E.05.59.0 (TF05).
- Depending on diameter of the adapter the flow rate can increase due to leakage between connecting pipe and rotating cleaning nozzle.



# Rotating cleaning nozzle “XactClean® HP+” Series 5S5

**NEW**

## Series 5S5

The XactClean® HP+ provides uniform cleaning and high impact, thanks to specially developed flat fan nozzles. Controlled rotation, along with higher flow rates, ensures effective results, especially in larger tanks. The robust drive unit makes the XactClean® HP+ extremely dependable and increases operational reliability. This nozzle is compatible with the Lechler rotation monitoring sensor, making it easy to oversee the cleaning process.

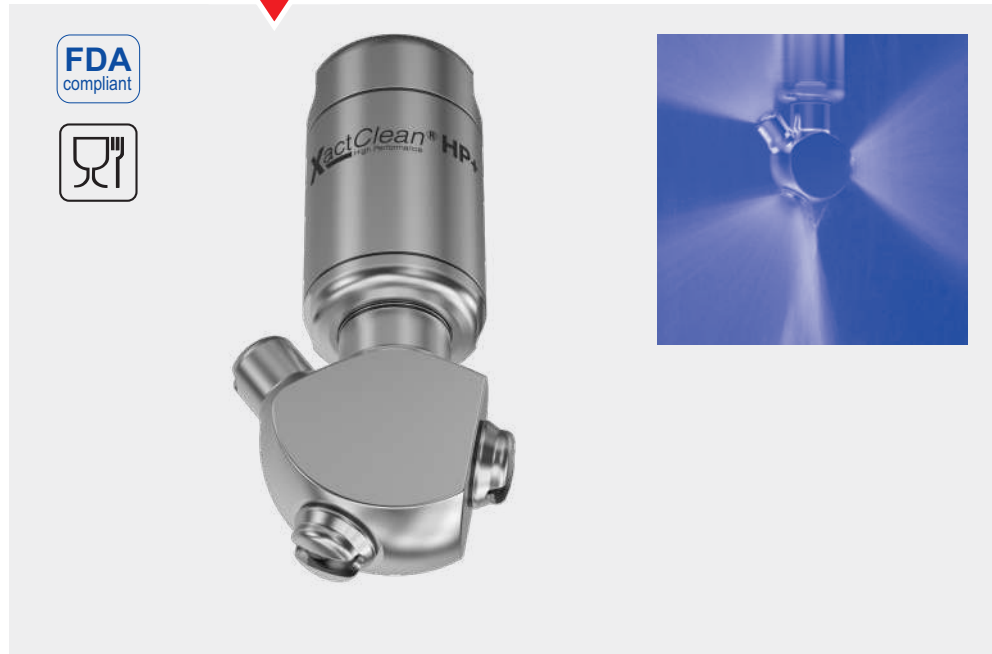

- Material**  
316L SS, 316 SS, PEEK, EPDM
- Max. temperature**  
203°F/95 °C
- Recommended operating pressure**  
45 psi
- Installation**  
Operation in every direction is possible
- Filtration**  
Line strainer with a mesh size of 0.3 mm/50 mesh
- Bearing**  
Double ball bearing
- Rotation monitoring sensor**  
Sensor compatible, please ask for more information.

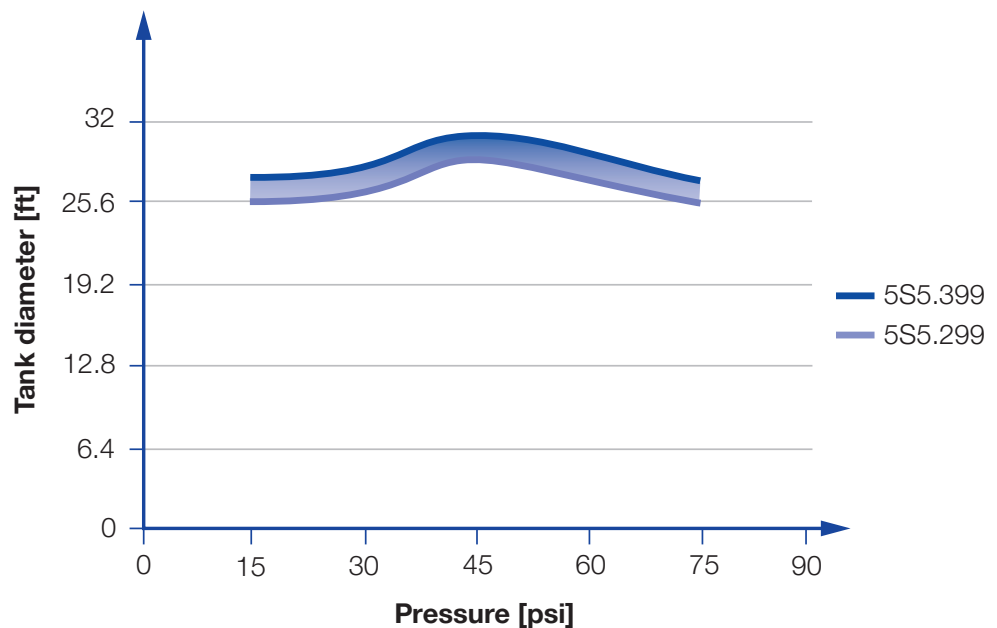

Overview of the tank diameter, depending upon the pressure of series 5S5

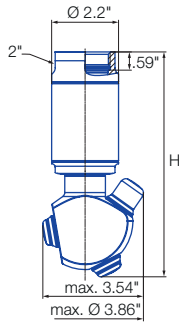



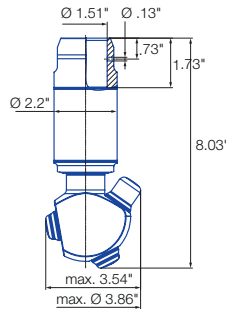



Female thread



Dimensions slip-on connection according to ASME-BPE (OD-tube)

### Nozzle dimensions [in]

Connection	Max. Height [H]
<b>BN</b>	7.28
<b>BQ</b>	7.28
<b>BS</b>	7.36

Spray angle 	Ordering no.					Free passage Ø [in]	Flow Rate (Gallons Per Minute)				Max. tank diameter [ft]
	Type	Connection					liters per minute 2 bar	30 psi	45 psi	75 psi	
		1 NPT	1 1/4 NPT	1 1/2 NPT	1 1/2" Slip-on						
180° 	<b>5S5.293.1Y</b>	<b>BN</b>	-	-	<b>TF15</b>	.12	165	44.3	54.3	70.1	29.5
	<b>5S5.323.1Y</b>	<b>BN</b>	<b>BQ</b>	-	<b>TF15</b>	.12	200	53.7	65.8	84.9	30.2
	<b>5S5.363.1Y</b>	-	<b>BQ</b>	<b>BS</b>	<b>TF15</b>	.12	250	67.2	82.3	106.1	30.8
180° 	<b>5S5.294.1Y</b>	<b>BN</b>	-	-	<b>TF15</b>	.12	165	44.3	54.3	70.1	29.5
	<b>5S5.324.1Y</b>	<b>BN</b>	<b>BQ</b>	-	<b>TF15</b>	.12	200	53.7	65.8	84.9	30.2
	<b>5S5.364.1Y</b>	-	<b>BQ</b>	<b>BS</b>	<b>TF15</b>	.12	250	67.2	82.3	106.1	30.8
270° 	<b>5S5.295.1Y</b>	<b>BN</b>	-	-	<b>TF15</b>	.12	165	44.3	54.3	70.1	29.5
	<b>5S5.325.1Y</b>	<b>BN</b>	<b>BQ</b>	-	<b>TF15</b>	.12	200	53.7	65.8	84.9	30.2
	<b>5S5.365.1Y</b>	-	<b>BQ</b>	<b>BS</b>	<b>TF15</b>	.12	250	67.2	82.3	106.1	30.8
270° 	<b>5S5.296.1Y</b>	<b>BN</b>	-	-	<b>TF15</b>	.12	165	44.3	54.3	70.1	29.5
	<b>5S5.326.1Y</b>	<b>BN</b>	<b>BQ</b>	-	<b>TF15</b>	.12	200	53.7	65.8	84.9	30.2
	<b>5S5.366.1Y</b>	-	<b>BQ</b>	<b>BS</b>	<b>TF15</b>	.12	250	67.2	82.3	106.1	30.8
360° 	<b>5S5.299.1Y</b>	<b>BN</b>	-	-	<b>TF15</b>	.12	165	44.3	54.3	70.1	29.5
	<b>5S5.329.1Y</b>	<b>BN</b>	<b>BQ</b>	-	<b>TF15</b>	.12	200	53.7	65.8	84.9	30.2
	<b>5S5.369.1Y</b>	-	<b>BQ</b>	<b>BS</b>	<b>TF15</b>	.12	250	67.2	82.3	106.1	30.8
	<b>5S5.399.1Y</b>	-	<b>BQ</b>	<b>BS</b>	<b>TF15</b>	.12	300	80.6	98.7	127.3	31.5

E = narrowest free cross-section · BSPP on request

The maximum tank diameter shown above applies for the recommended operating pressure and is indicative only. The cleaning result is also affected by the type of soiling.

### Information on operation

- Operation with compressed air only for short-term usage. Operation above the recommended operating pressure means higher wear and smaller droplets. This might have adverse effects on the cleaning result.

### Slip-on information

- R-clip made of 316L SS is included (Ordering no.: 095.013.1Y.06.45.0).
- Depending on diameter of the adapter the flow rate can increase due to leakage between connecting pipe and rotating cleaning nozzle.

Example of ordering: **5S5.293.1Y** + **BN** = **5S5.293.1Y.BN**



# Rotating cleaning nozzle “XactClean® HP2” Series 5S6/5S7

## Series 5S6/5S7

The XactClean® HP2 provides uniform cleaning and high impact, thanks to specially developed flat fan nozzles. Controlled rotation, along with higher flow rates, ensures effective results, especially in larger tanks. It is suitable for use with steam. This nozzle is compatible with the Lechler rotation monitoring sensor, making it easy to oversee the cleaning process.



**Material**  
Stainless steel 316L  
PEEK, EPDM

**Max. temperature**  
302°F/150 °C

**Recommended operating pressure**  
45 psi

**Installation**  
Operation in every direction is possible

**Filtration**  
Line strainer with a mesh size of 0.3 mm/50 mesh

**Bearing**  
Double ball bearing

**Rotation monitoring sensor**  
Sensor compatible, please ask for more information.

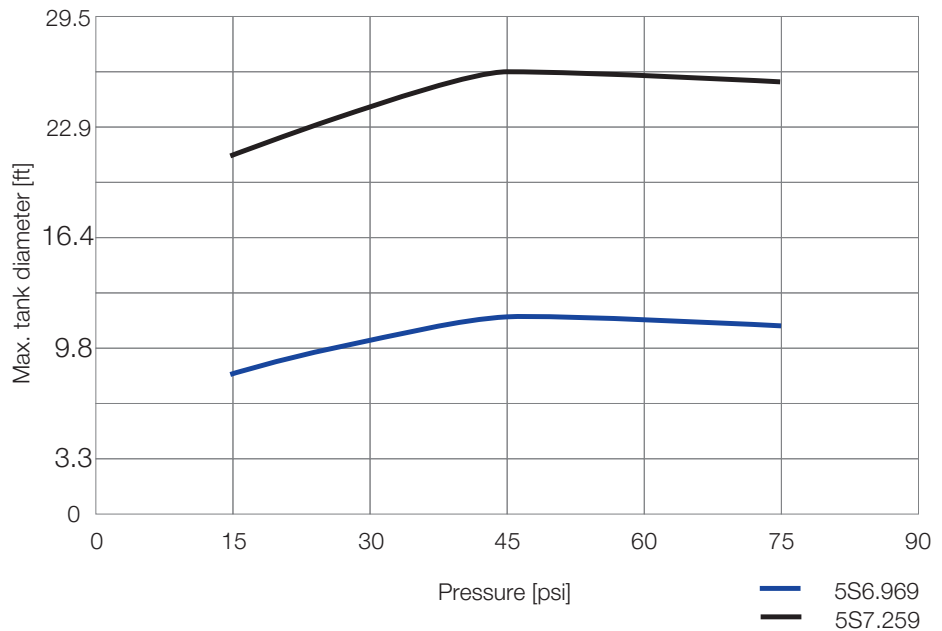

Overview of the tank diameter, depending upon the pressure of series 5S5

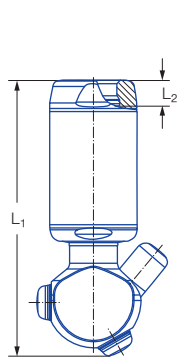

Female thread

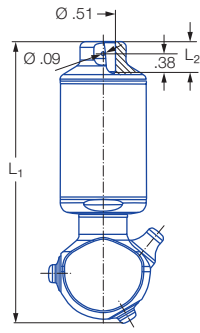

Dimensions of 1/2" slip-on connection according to ASME-BPE (OD tube)

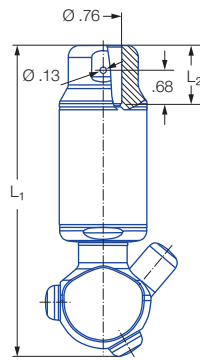



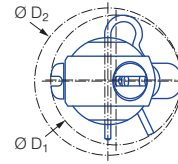

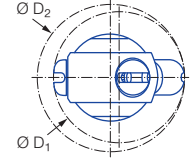

Dimensions of 3/4" slip-on connection according to ASME-BPE (OD tube)



Insertion diameter  $D_1$  and interference circle diameter  $D_2$  of the slip-on connection



Insertion diameter  $D_1$  and interference circle diameter  $D_2$  of the threaded connection

Spray angle 	Order number							Narrowest cross-section $\varnothing$ [in]	$\dot{V}$ water [gal/min]					Max. tank diameter [ft]
	Type	Connection							$p$ [psi]					
		3/8 NPT	1/2 NPT	3/4 NPT	1 NPT	1/2" slip-on connection	3/4" slip-on connection		30	45	3.0 bar	75	145	
180° 	5S6.963.1Y	BF	BH			TF05		0.07	6.60	8.19	31	10.57	15.06	11.5
	5S7.043.1Y		BH			TF07		0.08	10.83	13.21	50	17.17	24.30	13.1
	5S7.113.1Y		BH	BL		TF07		0.08	15.85	19.28	73	24.83	35.13	19.7
	5S7.183.1Y			BL		TF07		0.08	23.51	28.79	109	37.25	52.57	23.0
	5S7.223.1Y			BL		TF07		0.08	29.32	35.93	136	46.23	65.51	24.6
	5S7.253.1Y			BL	BN	TF07		0.08	35.66	43.59	165	56.27	79.52	26.2
180° 	5S6.964.1Y	BF	BH			TF05		0.07	6.60	8.19	31	10.57	15.06	11.5
	5S7.044.1Y		BH			TF07		0.08	10.83	13.21	50	17.17	24.30	13.1
	5S7.114.1Y		BH	BL		TF07		0.08	15.85	19.28	73	24.83	35.13	19.7
	5S7.184.1Y			BL		TF07		0.08	23.51	28.79	109	37.25	52.57	23.0
	5S7.224.1Y			BL		TF07		0.08	29.32	35.93	136	46.23	65.51	24.6
	5S7.254.1Y			BL	BN	TF07		0.08	35.66	43.59	165	56.27	79.52	26.2
270° 	5S6.965.1Y	BF	BH			TF05		0.07	6.60	8.19	31	10.57	15.06	11.5
	5S7.045.1Y		BH			TF07		0.08	10.83	13.21	50	17.17	24.30	13.1
	5S7.115.1Y		BH	BL		TF07		0.08	15.85	19.28	73	24.83	35.13	19.7
	5S7.185.1Y			BL		TF07		0.08	23.51	28.79	109	37.25	52.57	23.0
	5S7.225.1Y			BL		TF07		0.08	29.32	35.93	136	46.23	65.51	24.6
	5S7.255.1Y			BL	BN	TF07		0.08	35.66	43.59	165	56.27	79.52	26.2
270° 	5S6.966.1Y	BF	BH			TF05		0.07	6.60	8.19	31	10.57	15.06	11.5
	5S7.046.1Y		BH			TF07		0.08	10.83	13.21	50	17.17	24.30	13.1
	5S7.116.1Y		BH	BL		TF07		0.08	15.85	19.28	73	24.83	35.13	19.7
	5S7.186.1Y			BL		TF07		0.08	23.51	28.79	109	37.25	52.57	23.0
	5S7.226.1Y			BL		TF07		0.08	29.32	35.93	136	46.23	65.51	24.6
	5S7.256.1Y			BL	BN	TF07		0.08	35.66	43.59	165	56.27	79.52	26.2
360° 	5S6.969.1Y	BF	BH			TF05		0.06	6.60	8.19	31	10.57	15.06	11.5
	5S7.049.1Y		BH			TF07		0.08	10.83	13.21	50	17.17	24.30	13.1
	5S7.119.1Y		BH	BL		TF07		0.08	15.85	19.28	73	24.83	35.13	19.7
	5S7.189.1Y			BL		TF07		0.08	23.51	28.79	109	37.25	52.57	23.0
	5S7.229.1Y			BL		TF07		0.08	29.32	35.93	136	46.23	65.51	24.6
	5S7.259.1Y			BL	BN	TF07		0.08	35.66	43.59	165	56.27	79.52	26.2

\*BSPP on request

### Information on operation

- Operation with compressed air only for short-term usage. Operation above the recommended operating pressure means higher wear and smaller droplets. This might have adverse effects on the cleaning result.

<b>Example of ordering:</b>	<b>Type</b>	<b>+</b>	<b>Connection</b>	<b>=</b>	<b>Ordering no.</b>
5S7.259.1Y.		+	BN	=	5S7.259.1Y.BN

The maximum tank diameter shown above applies for the recommended operating pressure and is indicative only. The cleaning result is also affected by the type of soiling.

### Slip-on information

- R-clip made of 316L SS is included (Ordering no.: 095.013.1Y.06.45.0).
- Depending on diameter of the adapter the flow rate can increase due to leakage between connecting pipe and rotating cleaning nozzle.

# THE EFFECTIVE MEDIUM AGAINST THE MOST PERSISTENT SOILING

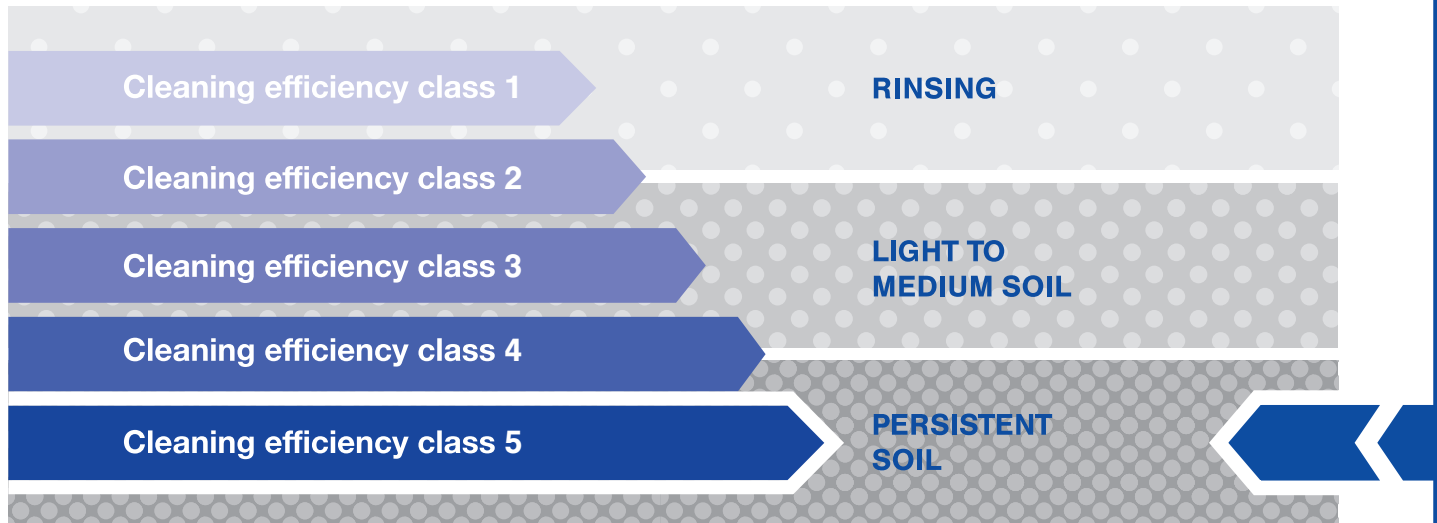

## Cleaning efficiency class 5

Heavy soiling requires special measures. That's why the Lechler high impact tank cleaning nozzles in Class 5 are equipped with high-grade gear units and work with deliberately controlled rotation. These nozzles have proven their capabilities precisely in the food and beverage industry, the chemical and petrochemical industry and the paper industry.

Solid jet nozzles ensure total cleaning efficiency with maximum impact. Class 5 includes rotating cleaners that are suitable for medium to very large tanks. Process reliability is increased through combination with the Lechler rotation monitoring sensor.

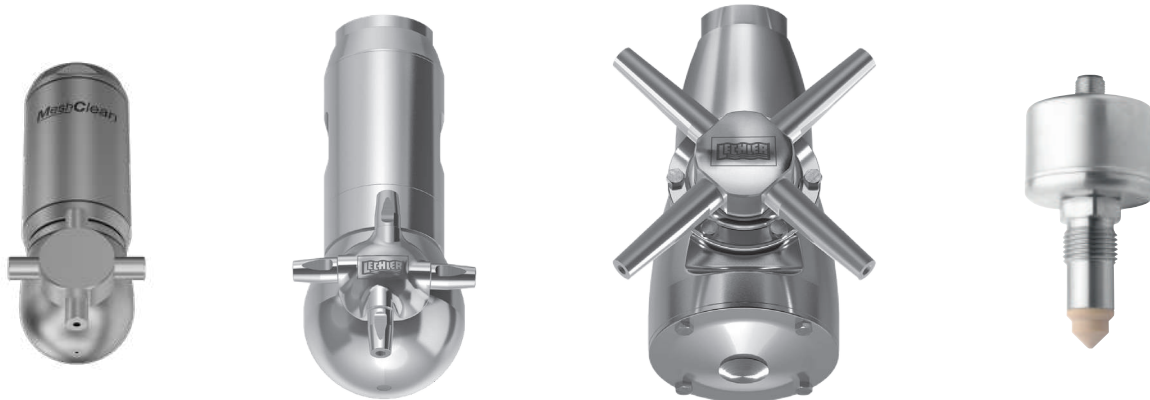

**Operating principles**  
Gear-controlled

**Flow rates at 30 psi**  
7 to 69 gpm

**Recommended operating pressures**  
75 psi

**Max. temperatures**  
140 to 203°F  
60 to 95°C





# High impact tank cleaning machine

## MeshClean

### Series 5T2/5T3

#### Series 5T2/5T3

The MeshClean is extremely effective thanks to the particularly powerful solid jet nozzles and is also suitable for small tanks with persistent soiling. The series is able to withstand pressures of up to 217 psi. The MeshClean is designed for the chemical and pharmaceutical industry as well as for the food and beverage industry.



 <b>Max. Tank diameter [ft]</b>	0	15	30	45	60
--	---	----	----	----	----

**Materials**  
Stainless steel 1.4404 (316L), PTFE, PEEK, EPDM

**Max. temperature**  
302°F/ 150°C

**Recommended operating pressure**  
75 psi

**Installation**  
Operates in every direction

**Filtration**  
Line strainer with a mesh size of 0.2 mm/80 Mesh

**Bearing**  
Ball bearing

**Weight**  
2.2 lbs

**Rotation monitoring sensor**  
Sensor compatible  
Info: see page 72

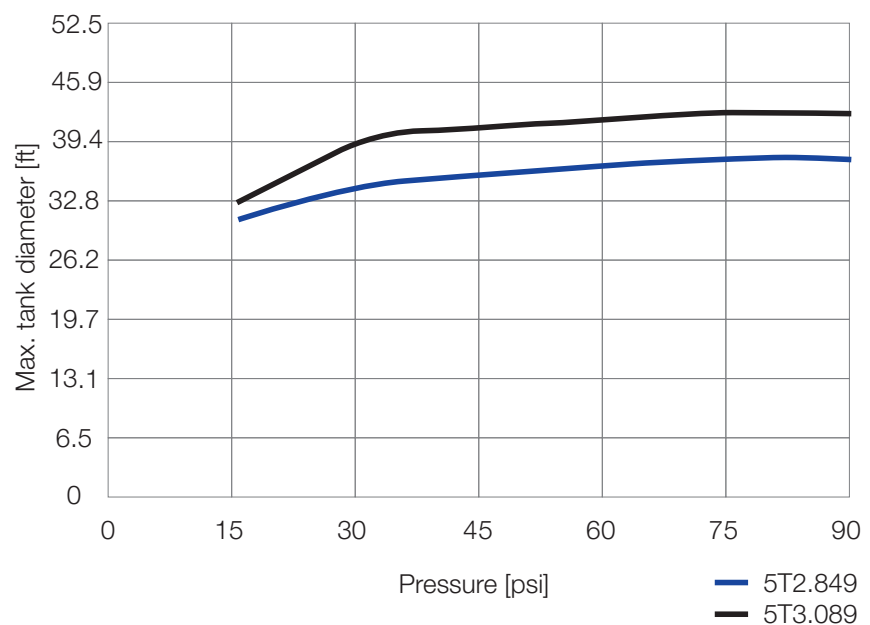

Overview of the tank diameter, depending upon the pressure of series 5T2/5T3

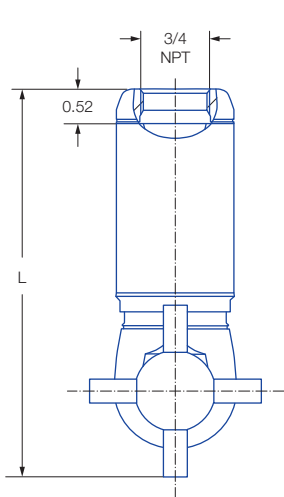

Female thread

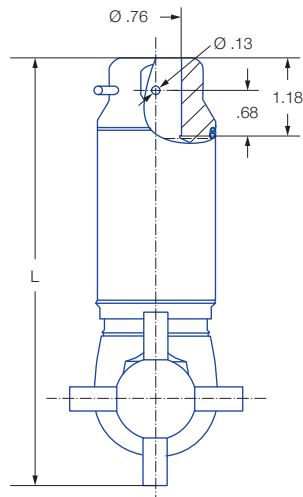

Dimensions of the slip-on connection according to ASME-BE (OD-tube)

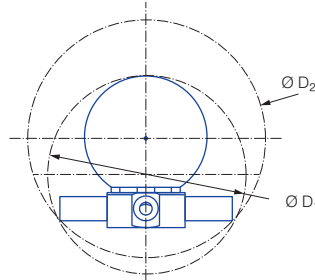

Insertion diameter  $D_1$  and interference circle diameter  $D_2$  of the threaded connection

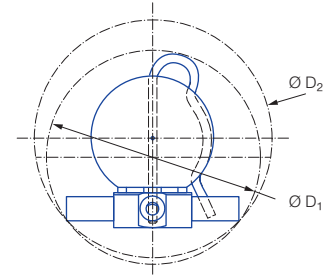

Insertion diameter  $D_1$  and interference circle diameter  $D_2$  of the slip-on connection

Spray angle	Ordering no.			Flow Rate (Gallons Per Minute)				Dimensions [in]						Max. tank diameter [ft]
	Type	Code		p [psi] ( $p_{max} = 218$ psi)				Female thread			Slip-on connection			
		3/4" NPT	3/4"-Slip-on connection	30	75	5.0	at 75 psi [SCFM]	L	$\varnothing D_1$	$\varnothing D_2$	L	$\varnothing D_1$	$\varnothing D_2$	
	5T2.849.1Y	BL	TF07	3.43	0.79	20	0.7	5.59	2.68	3.23	6.18	3.03	3.23	37.7
	5T2.969.1Y	BL	TF07	6.60	1.57	40	1.4	5.59	2.68	3.23	6.18	3.03	3.23	39.4
	5T3.029.1Y	BL	TF07	9.25	2.17	55	1.9	5.59	2.68	3.23	6.18	3.03	3.23	41.0
	5T3.089.1Y	BL	TF07	13.21	3.11	79	2.8	5.83	2.91	3.58	6.42	3.23	3.58	42.7

The maximum tank diameter shown above applies for the recommended operating pressure and is indicative only. The cleaning result is also affected by the type of soiling.

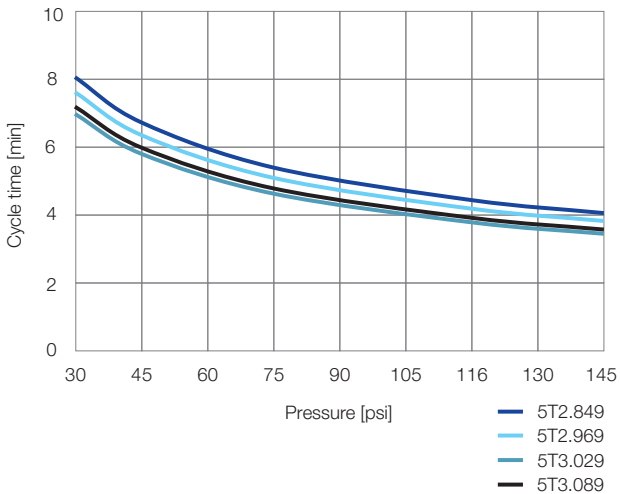

Cycle time depending on pressure of series 5T2/5T3

**Example of ordering with ATEX approval. FDA and (EG) 1935/2004 conform.**



**Unit group / category / zones:**

- II 1G Ex h LLB T6... T3 Ga
- II 1D Ex h IIIC T85 °C...T150 °C Da

Example Type/Ordering no. of ordering: 5T2.849.1Y.BL.EX

**Example of ordering with FDA and (EG) 1935/2004 conform.**



**All Materials are suitable for contact with food.**

Example Type/Ordering no. of ordering: 5T2.849.1Y.BL



# High impact tank cleaning machine

## Series 5TB

### Series 5TB

The 5TB has firmly established itself, above all in the pharmaceutical, food and beverage industries because of its hygienic design and high quality. The especially strong solid jets produce an extremely high degree of effectiveness, while the gear-controlled rotation ensures high levels of efficiency. This series is suitable for high pressures and temperatures.

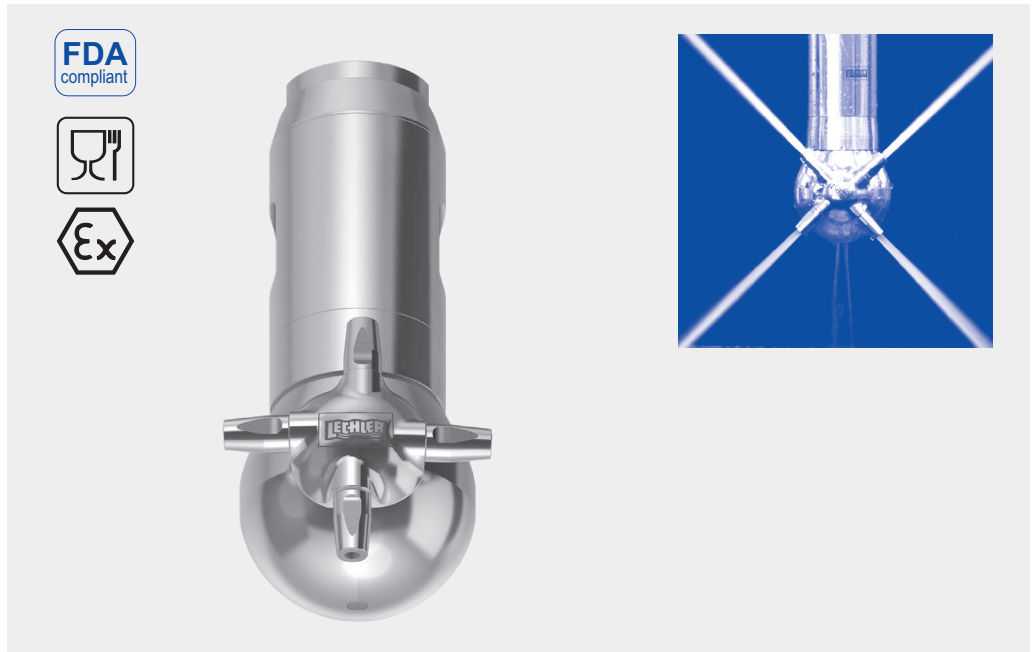

	<b>Max. Tank diameter [ft]</b>	0	15	30	45	60
--	--------------------------------	---	----	----	----	----

**Materials**  
AISI 316L SS, AISI 632, PTFE, PEEK, Zirconium oxide, EPDM, 32 RA surface finish is included with every material

**Max. temperature**  
203°F/ 95°C

**Recommended operating pressure**  
75 psi

**Installation**  
Operates in every direction

**Filtration**  
Line strainer with a mesh size of 0.2 mm/80 Mesh

**Bearing**  
Ball bearing

**Weight**  
8.8 lbs

**Rotation monitoring sensor**  
Sensor compatible  
Info: see page 72

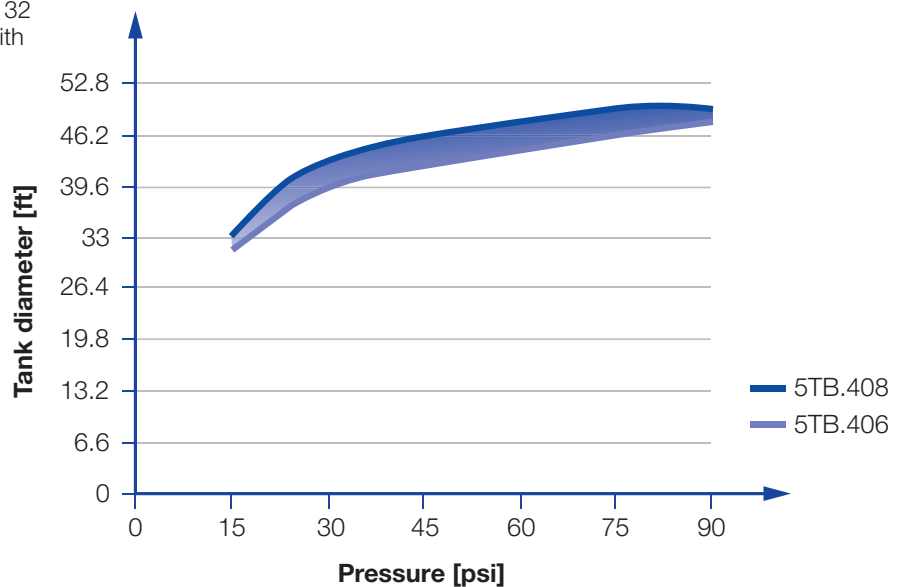

Overview of the tank diameter, depending upon the pressure of series 5TB

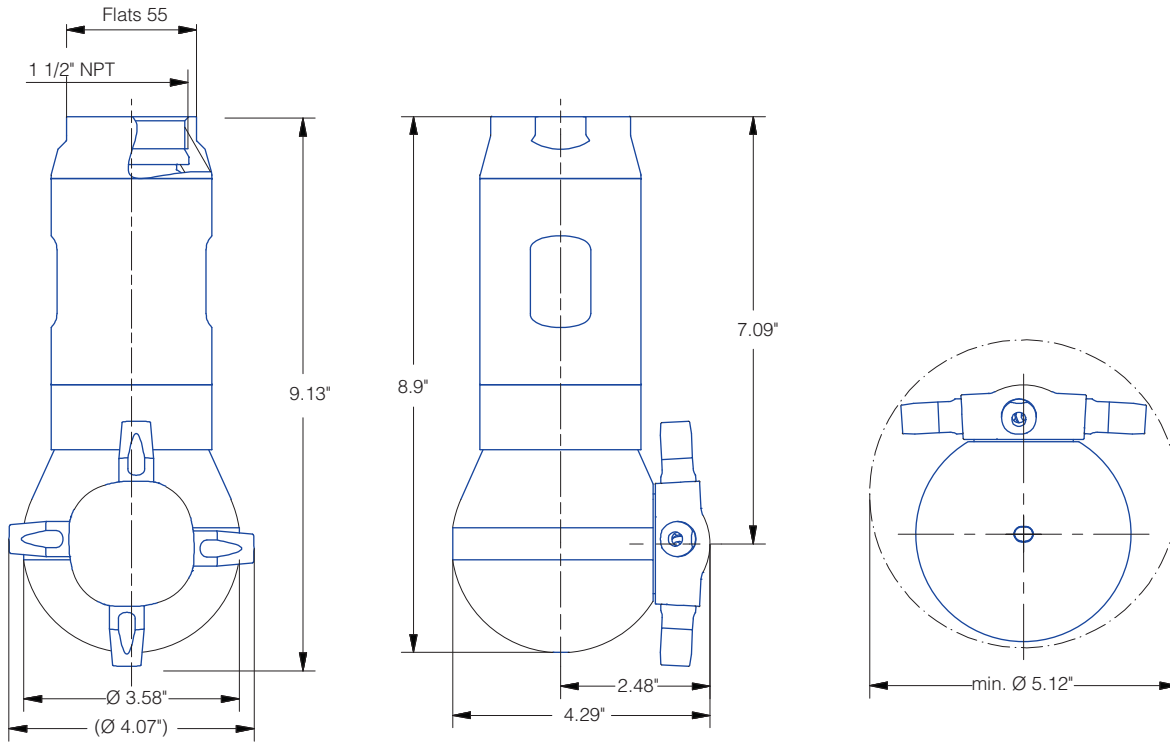

Spray angle	Ordering no.	Free Passage (in.)	Number, Ø Nozzles [mm]	Flow Rate (Gallons Per Minute)				Max pressure (psi)	Max. tank diameter [ft]	
				liters per minute 2 bar	30 psi	40 psi	75 psi			145 psi
	<b>5TB.406.1Y.BS</b>	.236	4 x 6.0	107	29	33	45	63	362	46
	<b>5TB.407.1Y.BS</b>	.236	4 x 7.0	132	35	41	56	78	362	46
	<b>5TB.408.1Y.BS</b>	.236	4 x 8.0	150	40	47	64	89	362	49

The maximum tank diameter shown above applies for the recommended operating pressure and is indicative only. The cleaning result is also affected by the type of soiling.

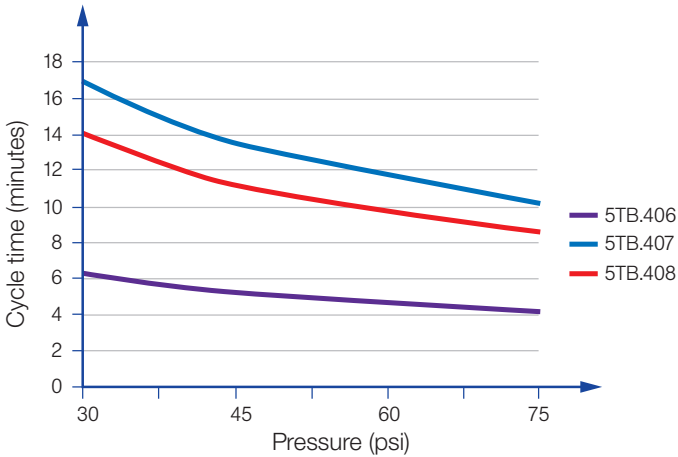

Cycle time depending on pressure of series 5TB

**Example of ordering with ATEX approval. FDA and (EG) 1935/2004 conform.**



**Unit group / category / zones:**

- ⊕ II 1G Ex h LLB T6... T3 Ga
- ⊕ II 1D Ex h IIIC T85 °C...T150 °C Da

Example Type/Ordering no.  
of ordering: 5TB.406.1Y.BS.EX

**Example of ordering with FDA and (EG) 1935/2004 conform.**



**All Materials are suitable for contact with food.**

Example Type/Ordering no.  
of ordering: 5TB.406.1Y.BL



# High impact tank cleaning machine Series 5TM

## Series 5TM

The 5TM is used for large tank cleaning applications. It is noted for its robust and proven construction, effective solid jets and gear-controlled rotation. This unit operates on low pressures while still providing excellent cleaning.

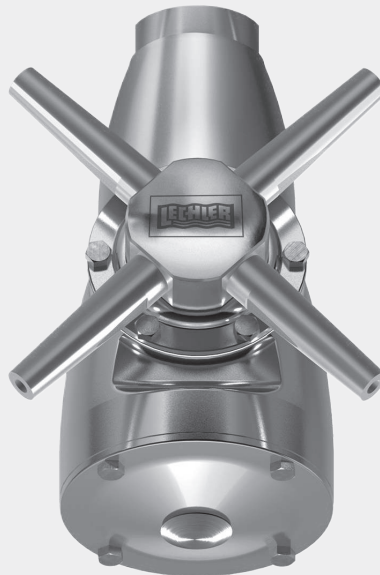

**Max. tank diameter [ft]**

0

20

40

60

80



**Materials**

316L, 304 SS, 302 SS, PTFE, PEEK



**Max. temperature**

5TM: 203°F/ 95°C



**Recommended operating pressure**

75 psi



**Installation**

Operates in every direction



**Filtration**

Line strainer with a mesh size of 0.2 mm/80 Mesh



**Bearing**

Ball bearing



**Weight**

16.5 lbs



**Rotation monitoring sensor**

Sensor compatible  
Info: see page 72

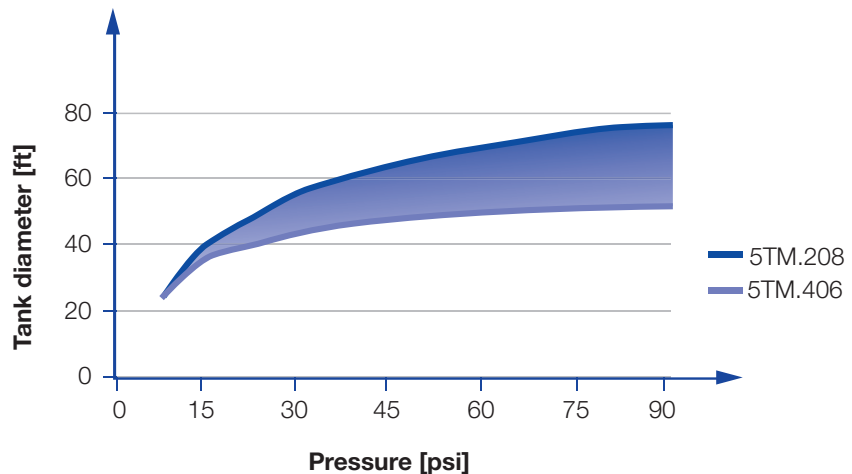

Overview of the tank diameter, depending upon the pressure of series 5TM



Our special mounting bracket provides the ability for the 5TM to reach the far ends of long horizontal tanks/ tankers. Mounting bracket part number: **099.164.17.00.0.0**

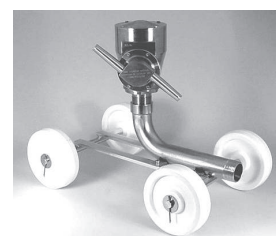

Portable cart for easier transporting of your 5TM from tank to tank. The cart part number is **M20.000.17.BR**. For use with "BR" connection only.

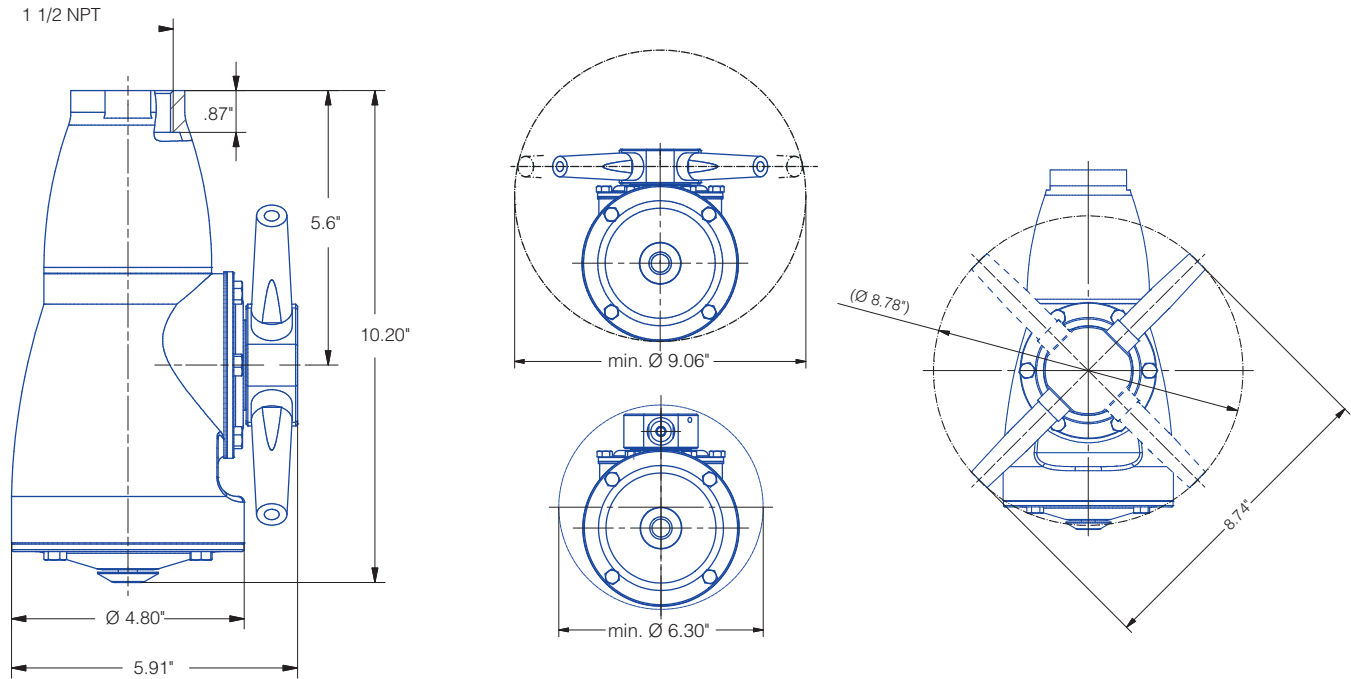

Ordering no.				Free Passage (in.)	No. of Nozzles x Diameter	Operating Pressure				Max. tank diameter [ft]
Type	Connection					40 psi	60 psi	80 psi	100 psi	
	1 1/2" Male NPT	1 1/2" Female NPT	1 1/2" CL150 Flange							
5TM. 208. 1Y	BR	BS	015	.314	2 x 8mm	39 gpm	48 gpm	55 gpm	61 gpm	79
5TM. 209. 1Y	BR	BS	015	.354	2 x 9mm	45 gpm	54 gpm	60 gpm	65 gpm	79
5TM. 210. 1Y	BR	BS	015	.394	2 x 10mm	50 gpm	61 gpm	70 gpm	79 gpm	79
5TM. 211. 1Y	BR	BS	015	.433	2 x 11mm	57 gpm	68 gpm	78 gpm	80 gpm	75
5TM. 406. 1Y	BR	BS	015	.236	4 x 6mm	43 gpm	53 gpm	61 gpm	69 gpm	59
5TM. 407. 1Y	BR	BS	015	.276	4 x 7mm	53 gpm	65 gpm	75 gpm	83 gpm	66
5TM. 408. 1Y	BR	BS	015	.315	4 x 8mm	62 gpm	76 gpm	88 gpm	98 gpm	72
5TM. 409. 1Y	BR	BS	015	.354	4 x 9mm	74 gpm	88 gpm	98 gpm	106 gpm	75
5TM. 410. 1Y	BR	BS	015	.394	4 x 10mm	81 gpm	99 gpm	114 gpm	128 gpm	75

ATEX available upon request

The maximum tank diameter shown above applies for the recommended operating pressure and is indicative only. The cleaning result is also affected by the type of soiling.

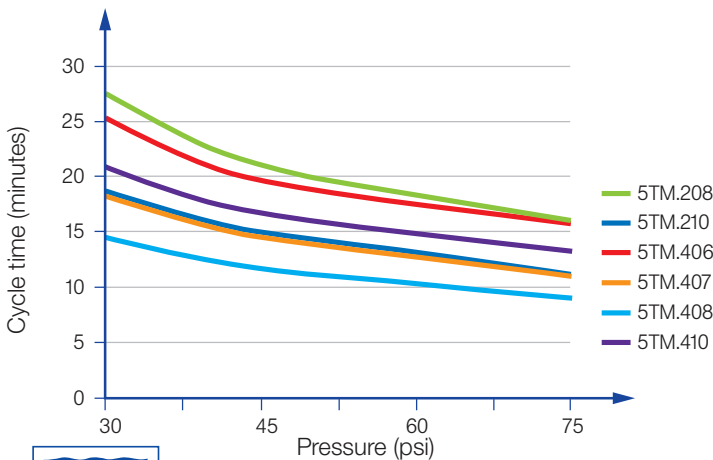

74 Cycle time depending on pressure of series 5TM





# Rotation Monitoring Sensor

Cleaning processes can be easily and reliably monitored with the Lechler rotation monitoring sensor. The sensor records the presence of liquid flowing over the sensor tip. With the aid of the supplied software, the sensor function can be specifically adjusted to the tank size, pressure and nozzle.



### Electrical data

- Supply voltage:  
Ub = 18 to 32 VDC
- Power requirements:  
< 20 mA
- Output signal:  
PNP, 50 mA short circuit protected, active

### Operating conditions

- Ambient internal temperature:  
-14° up to + 140°F
- Process external temperature:  
32° up to +212°F

### Materials

- Socket (G 1/2"): AISI 316L
- Probe tip: PEEK
- Body: AISI 303

### Advantages

- Reliable recognition of any faults during the cleaning cycle
- The process connection of the sensor is in compliance with the hygiene guidelines of the EHEDG
- Simple operation
- Can be connected to PLC
- Only needs to be set up once using the software provided
- Can be specifically adapted to each cleaning task

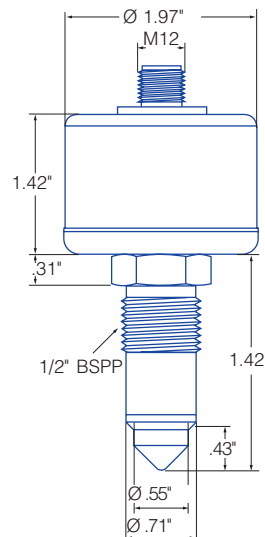

For use with series: 5S2, 5S3, 5T2/5T3, 5TB, 5TM, 5S3 & 5S5

Ordering data	Ordering no.
Rotation monitoring sensor with weld-in sleeve	050.040.00.00.00.0
Cable set for first-time operation	050.040.00.00.01.0





# Adapter »HygienicFit« Series 05C

## Series 05C

The HygienicFit ensures a hygienic connection between your tank cleaning nozzle and the supply line. The adaptor is welded onto the connection pipe, while the Lechler tank cleaning nozzle is screwed onto it. The O-rings on the adaptor completely encapsulate the thread, thereby providing a perfectly hygienic connection to the system. Through the use of the O-rings, the HygienicFit also offers a reliable thread lock.

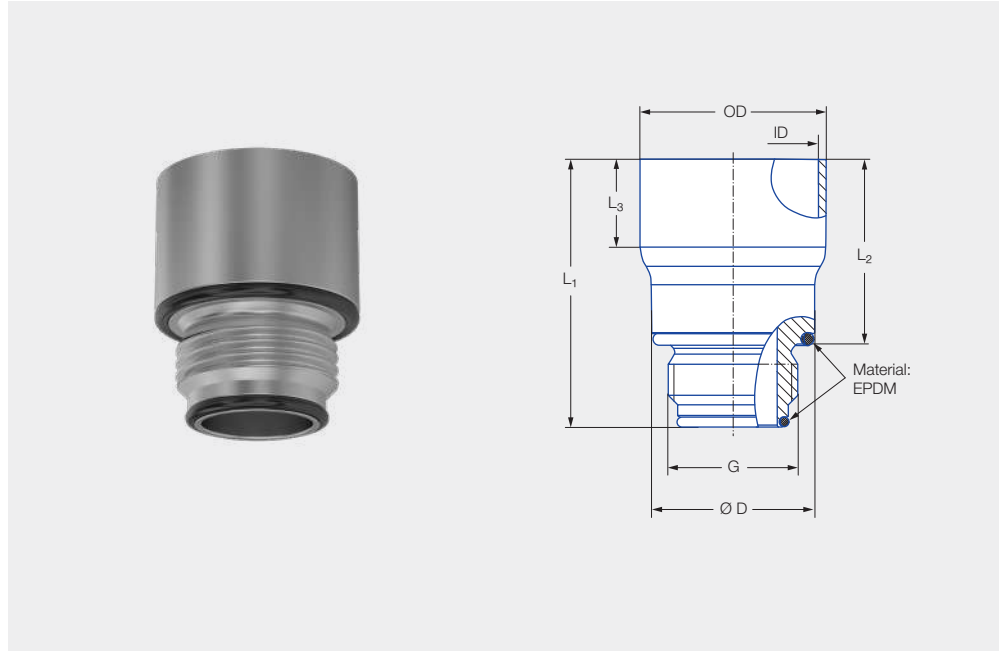

**Materials**  
316L SS;  
EPDM (O-Ring)



**Max. temperature**  
302 °F/ 150 °C



**Installation**

Ordering no.	Connection thread BSPP male	Dimensions [in]				Dimensions OD = Outer dia- meter ID = Inner diameter [in]		Pipe standard
		L <sub>1</sub>	L <sub>2</sub>	L <sub>3</sub>	Ø D	OD	ID	
<b>05C.190.1Y.AE.16</b>	3/8	1.89	1.41	.71	.85	.75	.62	DIN EN 10357 series D
<b>05C.230.1Y.AE.15</b>	3/8	1.89	1.41	.71	.85	.91	.79	DIN EN 10357 series A
<b>05C.250.1Y.AE.12</b>	3/8	1.89	1.41	.67	.85	.98	22,6	DIN EN 10357 series D
<b>05C.250.1Y.AG.12</b>	1/2	2.20	1.54	.71	1.22	.98	.89	DIN EN 10357 series D
<b>05C.350.1Y.AK.15</b>	3/4	2.17	1.49	.83	1.32	1.38	1.26	DIN EN 10357 series A
<b>05C.380.1Y.AK.12</b>	3/4	2.17	1.49	.71	1.32	1.50	1.40	ISO 2037
<b>05C.381.1Y.AK.15</b>	3/4	2.17	1.49	.71	1.32	1.50	1.39	DIN EN 10357 series D
<b>05C.381.1Y.AM.16</b>	1	2.32	1.54	.91	1.59	1.50	1.37	DIN EN 10357 series D
<b>05C.508.1Y.AP.15</b>	1 1/4	2.24	1.50	.87	1.94	2.00	1.88	DIN EN 10357 series D
<b>05C.635.1Y.AR.16</b>	1 1/2	2.48	1.73	.87	2.20	2.50	2.37	DIN EN 10357 series D

### Spare parts set of O-rings, EPDM

Thread type BSPP	Ordering no.
3/8	<b>05C.000.E9.AE.00</b>
1/2	<b>05C.000.E9.AG.00</b>
3/4	<b>05C.000.E9.AK.00</b>
1	<b>05C.000.E9.AM.00</b>
1 1/4	<b>05C.000.E9.AP.00</b>
1 1/2	<b>05C.000.E9.AR.00</b>

O-ring set is also available on request in FKM.



## FOR SPECIAL REQUIREMENTS: OUR STATIC CLEANING NOZZLES

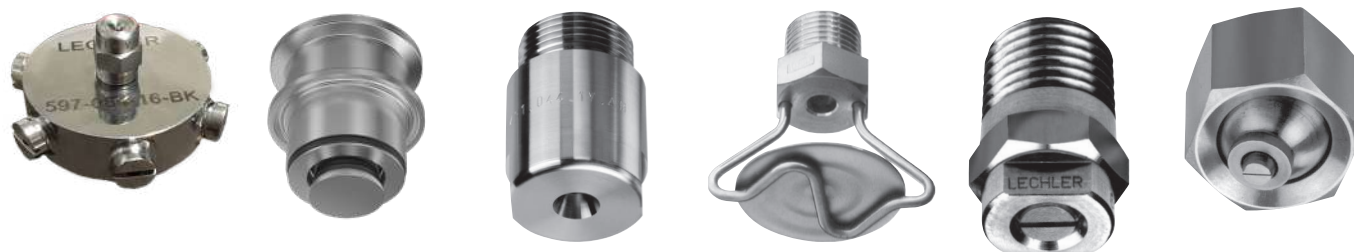
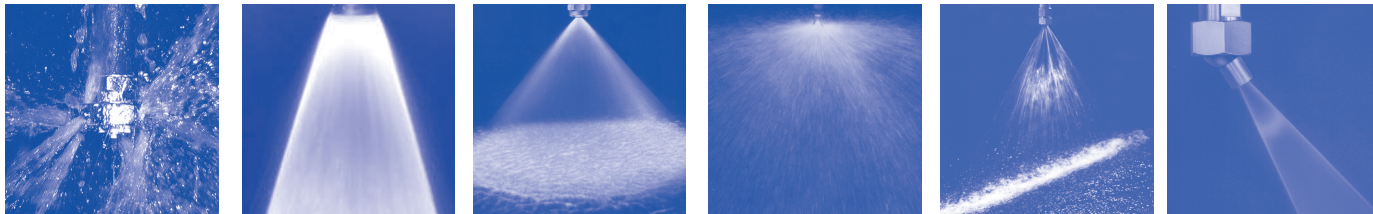

### Static cleaning nozzles

The range of applications for the static cleaning nozzles provide support for rotating cleaners focusing on particularly difficult tasks, such as equipment cleaning and the avoidance of spray shadows.

These types of static nozzles reach hard to access places while removing persistent soiling — which rotating cleaners or spray balls cannot.

# Special cleaning nozzles Flushing Nozzle Assembly Series 597

## Series 597

The flushing nozzle assembly was designed especially for the brewing industry for cleaning the plate screen in lauter tun tanks. A full cone nozzle inserted at the bottom delivers excellent spray coverage and the flat fan jets provide powerful impact for cleaning.



**Materials**  
304 SS, PTFE



**Max. temperature**  
194°F/ 90°C



**Recommended operating pressure**  
45 psi



**Installation**  
Vertically facing upward



**Filtration**  
Line strainer with a mesh size of 0.3 mm/50 mesh

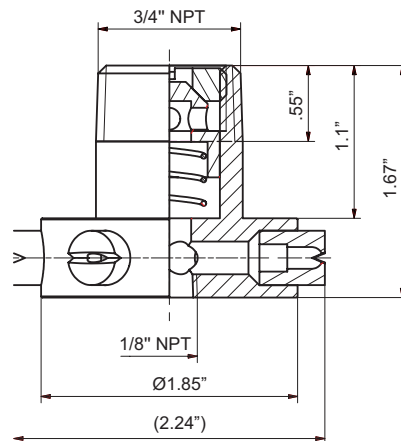

Uses full cone nozzle series 490.568.1Y.BA

Ordering no.		Flow Rate (Gallons Per Minute)				
Type	Connection	20 psi	liters per minute 2 bar	30 psi	45 psi	60 psi
	3/4" NPT					
<b>597.085.1C</b>	<b>BK</b>	5	22	6	7.2	8.5

### Information on operation

- Operation with compressed air purge only for short-term usage. Operation above the recommended operating pressure means higher wear and smaller droplets. This might have adverse effects on the cleaning result.

# PopUp Clean Series 5P5

**NEW**

## Series 5P5

The series PopUp Clean is used for cleaning agitators or other spray shadow areas. The tank cleaning nozzle made of high-quality materials convinces with its compact and robust design and can be installed flush with the wall.

FDA  
compliant



	<b>Max. tank diameter [ft]</b>	0	5	10	15	20	25
--	--------------------------------	---	---	----	----	----	----



### Material

316L SS,  
316Ti SS (spring),  
316 SS (snap ring),  
FKM (O-ring)



### Max. temperature

203°F/95 °C



### Recommended operating pressure

30-75 psi



### Installation

Operation in every direction is possible



### Filtration

Line strainer with a mesh size of 0.3 mm/50 mesh

### Information on operation

The PopUp Clean is not suitable for operation with compressed air or any other gas.

Spray angle	Ordering no.	Free Passage (in.)	Flow Rate (Gallons Per Minute)					Max. tank diameter [ft]
			20 psi	2 bar	30 psi	40 psi	60 psi	
30°	5P5.081.1Y.00.00.0	.03	11	50	13	16	19	9.8

E = Narrowest free cross-section

\*This product is also available in a ATEX version

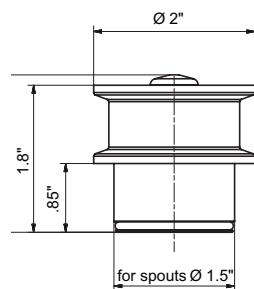

Nozzle installation

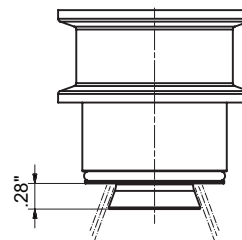

Weld-in flange

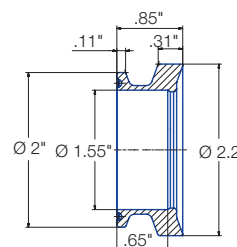
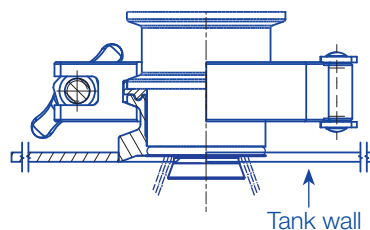
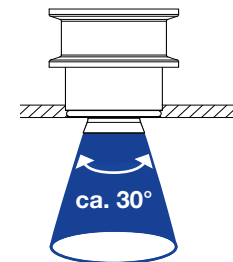

### Ordering no.

050.020.1Y.01.00

### Material

316L SS

### Information

Gasket with a thickness of .08 in. must be used with weld-in-flange. Not sold with nozzle. Use standard DIN32676-A / DN40



# Axial-flow full cone nozzles

## Series 490 / 491

**Clog-resistant design. Stable spray angle. Particularly even liquid distribution.**



Series 490



Series 491

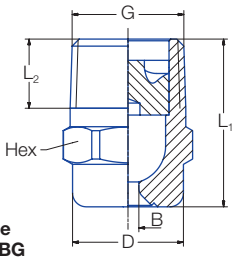

Code BC-BG

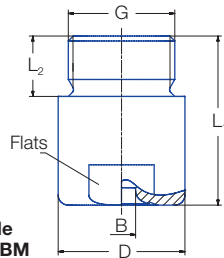



Code BK-BM

Code	Dimensions (in.)					Weight Brass
	G	L <sub>1</sub>	L <sub>2</sub>	D	Hex/Flat	
<b>BC</b>	1/4 NPT	0.87	0.39	0.51	9/16	.04
<b>BE</b>	3/8 NPT	0.96	0.39	0.63	11/16	.07
<b>BE</b>	3/8 NPT	1.18	0.39	0.63	11/16	.11
<b>BG</b>	1/2 NPT	1.28	0.51	0.83	14/16	.13
<b>BG</b>	1/2 NPT	1.71	0.51	0.83	14/16	.19
<b>BK</b>	3/4 NPT	1.65	0.59	1.26	1-1/16	.42
<b>BK</b>	3/4 NPT	1.97	0.59	1.26	1-1/16	.44
<b>BM</b>	1 NPT	2.20	0.67	1.57	1-7/16	.77

Subject to technical modification.

In a critical installation situation, please ask for the exact dimensions.

Spray angle 	Type	Ordering no.							Orifice diam. (in.)	Free Passage (in.)	Flow Rate (Gallons Per Minute)										Spray diameter D at 30 psi 	
		Mat.no. 1Y	Mat.no. 30	Connection Male NPT							10 psi	20 psi	liters per minute 2 bar	30 psi	40 psi	60 psi	80 psi	100 psi	150 psi	H = 8"	H = 20"	
				AISI 316L	Brass	1/8"	1/4"	3/8"														1/2"
60°	<b>490. 644</b>	○	○	-	<b>BC</b>	<b>BE</b>	-	-	-	.091	.091	.69	.091	4.00	1.07	1.20	1.41	1.59	1.73	2.04	9	22
	<b>490. 684</b>	○	○	-	<b>BC</b>	<b>BE</b>	-	-	-	.102	.102	.86	1.14	5.00	1.34	1.50	1.77	1.98	2.17	2.55	9	22
	<b>490. 724</b>	○	○	-	<b>BC</b>	<b>BE</b>	-	-	-	.112	.110	1.09	1.43	6.30	1.69	1.89	2.23	2.50	2.73	3.21	9	22
	<b>490. 764</b>	○	○	-	-	<b>BE</b>	-	-	-	.128	.128	1.38	1.82	8.00	2.14	2.40	2.83	3.17	3.47	4.08	9	22
	<b>490. 804</b>	○	○	-	-	<b>BE</b>	-	-	-	.146	.146	1.72	2.28	10.00	2.68	3.00	3.53	3.97	4.34	5.10	9	22
	<b>490. 844</b>	○	○	-	-	-	<b>BG</b>	-	-	.159	.159	2.16	2.85	12.50	3.35	3.76	4.42	4.96	5.42	6.37	9	22
	<b>490. 884</b>	○	○	-	-	-	<b>BG</b>	-	-	.183	.183	2.76	3.67	16.00	4.28	4.81	5.65	6.34	6.94	8.16	9	22
	<b>490. 924</b>	○	○	-	-	-	-	<b>BK</b>	-	.205	.205	3.45	4.56	20.00	5.36	6.01	7.07	7.93	8.67	10.20	9	22
	<b>490. 964</b>	○	○	-	-	-	-	<b>BK</b>	-	.228	.228	4.31	5.69	25.00	6.70	7.51	8.83	9.91	10.84	12.74	9	22
	<b>491. 044</b>	○	○	-	-	-	-	-	<b>BM</b>	.285	.285	6.90	9.11	40.00	10.71	12.02	14.14	15.86	17.34	20.39	9	22
	<b>491. 084</b>	○	○	-	-	-	-	-	<b>BM</b>	.321	.321	8.63	11.38	50.00	13.39	15.02	17.67	19.82	21.67	25.49	9	22



# Deflector-plate nozzle Series 524 / 525

Full cone spray has no swirl insert for greater clog resistance.

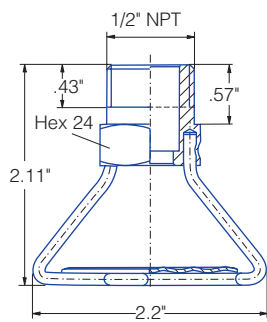

**Type 524. 809 – 525. 269**

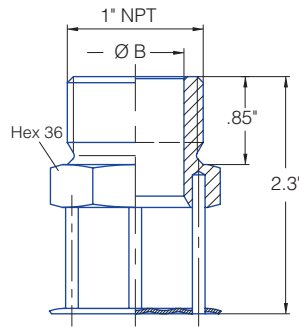

**Type 525. 349 – 525. 489**

Spray angle 	Ordering no.			Orifice diam.	Flow Rate (Gallons Per Minute)								Spray Diameter D (ft.)  (ft) @ 45 psi	
	Type	Mat. no.			10 psi	20 psi	liters per minute 2 bar	40 psi	60 psi	80 psi	100 psi	150 psi		
		Connection: 1/2" Male NPT	17 316 SS										30 Brass	
180°	<b>524. 809</b>	○	○	.158	1.6	7.10	10	3.1	3.8	4.4	4.9	6.0	18	21
	<b>525. 049</b>	○	○	.315	6.2	8.8	40	12.4	15.2	17.6	19.6	24	33	43
	<b>525. 109</b>	-	○	.366	8.8	12.5	57	17.7	22	25	28	34	33	44
	<b>525. 169</b>	-	○	.429	12.6	17.8	81	25	31	36	40	49	35	44
	<b>525. 229</b>	-	○	.481	17.4	25	112	35	43	49	55	67	22	34
	<b>525. 489</b>	○	○	.485	22	31	140	43	53	61	69	84	17	33



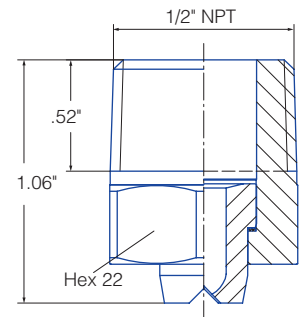
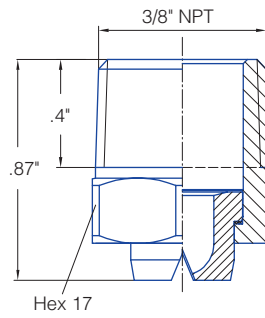
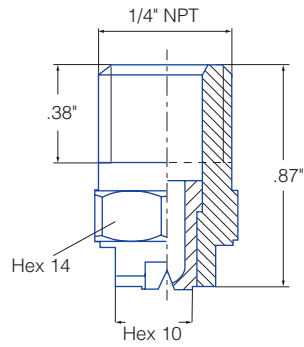

# Flat fan nozzles Series 632 / 633

Standard design with conical, self-sealing thread connection. Stable spray angle. Uniform, parabolic distribution of liquid.





Spray angle 	Ordering no.								Equivalent Orifice diam. (in.)	Free Passage (in.)	Flow Rate (Gallons Per Minute)							Spray width B at p=2 bar  H = 10" B = 20"	
	Type	Material no.				Connection					10 psi	20 psi	liters per minute 2 bar	40 psi	60 psi	80 psi	100 psi	5	9
		303 SS 16	316 SSSS 17 <sup>1)</sup>	Brass 30	PVDF 5E	Male NPT													
						1/4"	3/8"	1/2"											
30°	632. 722	○	○	○	-	BC	BE	-	.118	.095	.98	1.4	6.3	2.0	2.4	2.8	3.1	5	9
	632. 802	○	○	○	-	BC	BE	-	.158	.122	1.6	2.2	10.0	3.1	3.8	4.4	4.9	5	10
45°	632. 673	○	○	○	-	BC	BE	BG	.106	.083	.74	1.0	4.8	1.5	1.8	2.1	2.3	8	15
	632. 723	○	○	○	-	BC	BE	BG	.118	.095	.98	1.4	6.3	2.0	2.4	2.8	3.1	8	15
	632. 803	○	○	○	-	BC	BE	BG	.158	.118	1.6	2.2	10.0	3.1	3.8	4.4	4.9	8	15
	632. 843	○	○	○	-	-	-	BG	.177	.138	1.9	2.7	12.5	3.9	4.8	5.5	6.1	8	15
	632. 883	○*	○*	○*	○*	BC	-	BG	.197	.157	2.5	3.5	16.0	5.0	6.1	7.0	7.9	9	17
	632. 923	○	○	○	-	-	-	BG	.217	.165	3.1	4.4	20.0	6.2	7.6	8.8	9.8	9	17
	632. 963	○	○	○	-	-	-	BG	2.36	.185	3.9	5.5	25.0	7.8	9.5	11.0	12.3	9	17
60°	632. 644	○	○	○	-	BC	-	-	.099	.063	.62	.88	4.0	1.2	1.5	1.8	2.0	12	22
	632. 674	○	○	○	○	BC	BE	BG	.106	.071	.74	1.0	4.8	1.5	1.8	2.1	2.3	12	23
	632. 724	○	○	○	○	BC	BE	BG	.118	.083	.98	1.4	6.3	2.0	2.4	2.8	3.1	12	23
	632. 764	○	○	○	-	BC	BE	-	.138	.091	1.2	1.8	8.0	2.5	3.0	3.5	3.9	12	23
	632. 804	○	○	○	○*	BC	-	BG	.158	.102	1.6	2.2	10.0	3.1	3.8	4.4	4.9	12	23
	632. 844	○	○	○	○*	BC	-	BG	.177	.118	1.9	2.7	12.5	3.9	4.8	5.5	6.1	12	23
	632. 884	○	○	○	○*	BC	-	BG	.197	.134	2.5	3.5	16.0	5.0	6.1	7.0	7.9	12	22
	632. 924	○	○*	○*	○	BC	-	BG	.217	.165	3.1	4.4	20.0	6.2	7.6	8.8	9.8	13	25
	632. 964	○	○	○	-	-	-	BG	.236	.185	3.9	5.5	25.0	7.8	9.5	11.0	12.3	13	25
	633. 004	○	○	-	-	-	-	BG	.276	.205	4.9	6.9	31.5	9.8	12.0	13.9	15.5	13	25
632. 084	○	○	○	-	-	-	BG	.354	.268	7.7	11.0	50.0	15.5	19.0	21.9	24.5	13	25	

<sup>1</sup>We reserve the right to deliver AISI 303 or AISI 304 under the material no. 16.

\* Only available with connection BC.

+ Only available with connection BG.

Subject to technical modifications.

**Example**    Type    +    Material no.    +    Code    =    Ordering no.  
of ordering: 632. 642. + 16                    + BC    =    632. 642. 16. BC



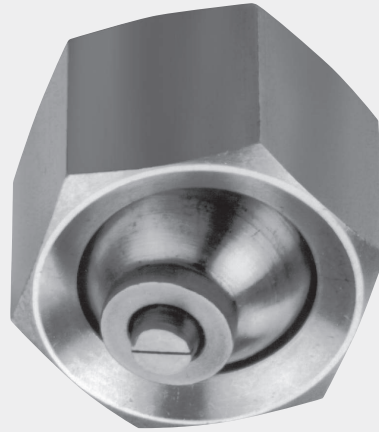
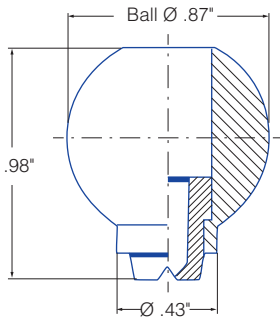

# Flat fan nozzles with ball joint Series 676

Flat fan nozzle swivels for precise adjusting of spray direction. Designed for long service life.



Adjustable swivel range up to 30°

Spray angle 	Ordering no.		Equivalent Orifice diameter (in.)	Free passage (in.)	Flow Rate (Gallons Per Minute)						Spray width B  (in.) @ 30 psi	
	Type	Mat.no.			20 psi	liters per minute	40 psi	60 psi	80 psi	100 psi	H = 10"	H = 20"
30°	676. 642	○	.098	.071	.88	4.0	1.2	1.5	1.8	2.0	5	9
	676. 722	○	.118	.071	1.4	6.3	2.0	2.4	2.8	3.1	5	9
	676. 762	○	.139	.106	1.8	8.0	2.5	3.0	3.5	3.9	5	10
	676. 802	○	.157	.122	2.2	10	3.1	3.8	4.4	4.9	5	10
45°	676. 643	○	.098	.071	.88	4.0	1.2	1.5	1.8	2.0	8	15
	676. 723	○	.118	.094	1.4	6.3	2.0	2.4	2.8	3.1	8	15
	676. 763	○	.138	.102	1.8	8.0	2.5	3.0	3.5	3.9	8	15
	676. 803	○	.157	.118	2.2	10.0	3.1	3.8	4.4	4.9	8	15
60°	676. 644	○	.098	.063	.88	4.0	1.2	1.5	1.8	2.0	12	22
	676. 674	○	.106	.071	1.0	4.8	1.5	1.8	2.1	2.3	12	23
	676. 724	○	.118	.083	1.4	6.3	2.0	2.4	2.8	3.1	12	23
	676. 764	○	.138	.091	1.8	8.0	2.5	3.0	3.5	3.9	12	23



# Flat fan nozzles with ball joint Series 676 – Accessories

**Retaining nut**  
092. 020. 16. 00. 02  
Material: AISI 303

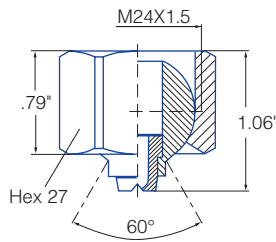

**Socket**  
092. 020. 16. AF. 03  
Material: AISI 303

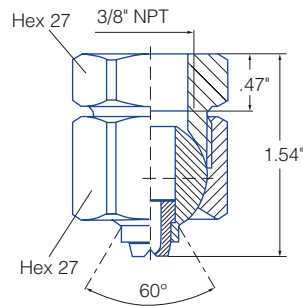

**Retaining nipple**  
092. 024. 16. AC. 03  
Material: AISI 303

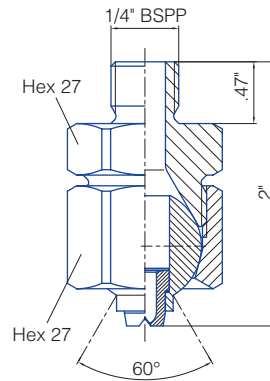

**Welding nipple**  
092. 020. 17. 00. 04  
Material: AISI 316Ti

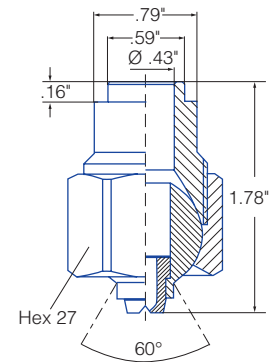

## Compact ball joints for narrow installation conditions

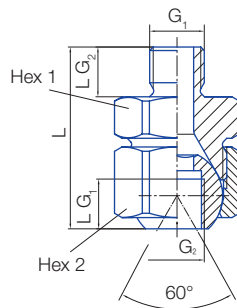

For series	Ordering no.			Dimensions						
	Type	Mat. no.	Code	G <sub>1</sub> BSPP	G <sub>2</sub> BSPP	L <sub>G1</sub> (in.)	L <sub>G2</sub> (in.)	L (in.)	Hex <sub>1</sub>	Hex <sub>2</sub>
		16								
For all nozzles with 1/8" male thread	092. 010	○	BB	1/8A	1/8	.24	.24	1.69	22	24
For all nozzles with 1/4" male thread	092. 024	○	BD	1/4A	1/4	.28	.28	1.69	27	27
For all nozzles with 3/8" male thread	092. 030	○	BF	3/8A	3/8	.28	.28	2.28	27	30



ENGINEERING  
YOUR SPRAY SOLUTION



## LECHLER WORLD-WIDE

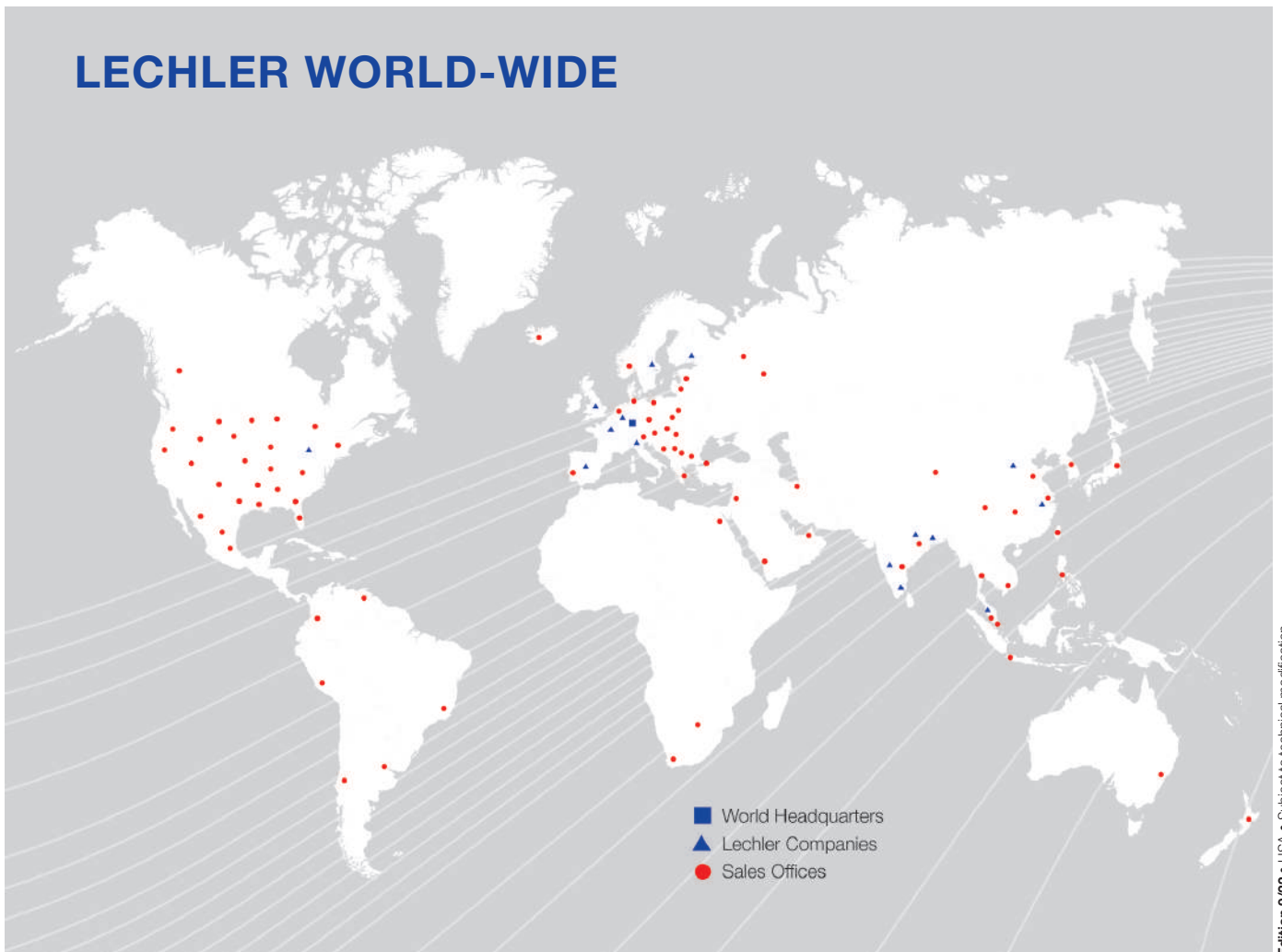

Edition 9/22 • USA • Subject to technical modification

### Lechler, Inc. • Precision Nozzles • Nozzle Systems

445 Kautz Road, St. Charles, IL 60174 • Phone (800) 777-2926 • Fax (630) 377-6657 • [info@LechlerUSA.com](mailto:info@LechlerUSA.com) • [www.LechlerUSA.com](http://www.LechlerUSA.com)

**ASEAN:** Lechler Spray Technology Sdn. Bhd. • No. 23, Jalan Teknologi 3/3A • Taman Sains Selangor 1 • Kota Damansara, PJU 5 • 47810 Petaling Jaya • Malaysia • [info@lechler.com.my](mailto:info@lechler.com.my)

**Belgium:** Lechler S.A./N.V. • Avenue Mercator, 6 • 1300 Wavre • Phone: +32 10 225022 • Fax: +32 10 243901 • [info@lechler.be](mailto:info@lechler.be)

**China:** Lechler Intl. Trad. Co. Ltd. • Beijing • Rm. 418 Landmark Tower • No. 8 Dong San Huan Bei Lu • Phone: +86 10 84537968, Fax: +86 10 84537458 • [info@lechler.com.cn](mailto:info@lechler.com.cn)

**Finland:** Lechler Oy • Jäspilänkatu 18 • 04250 Kerava • Phone: +358 207 856880 • Fax: +358 207 856881 • [info@lechler.fi](mailto:info@lechler.fi)

**France:** Lechler France, S.A. • Bât. CAP2 • 66-72, Rue Marceau • 93558 Montreuil • Phone: +33 1 49882600 • Fax: +33 1 49882609 • [info@lechler.fr](mailto:info@lechler.fr)

**Germany:** Lechler GmbH • PO Box 13 23 • 72544 Metzingen • Phone: +49 7123 962-0 • Fax: (49) 7123 962-444 • [info@lechler.de](mailto:info@lechler.de)

**Great Britain:** Lechler Ltd. • 1 Fell Street, Newhall • Sheffield, S9 2TP • Phone: +44 114 2492020 • Fax: +44 114 2493600 • [info@lechler.com](mailto:info@lechler.com)

**India:** Lechler (India) Pvt. Ltd. • Plot B-2 • Main Road • Wagle Industrial Estate • Thane (W) - 400604 • Phone: +91 22 40634444 • Fax: +91 22 40634498 • [lechler@lechlerindia.com](mailto:lechler@lechlerindia.com)

**Italy:** Lechler Spray Technology S.r.l. • Via Don Dossetti, 2 • 20080 Carpiano (MI) • Phone: +39 02 98859027 • Fax: +39 02 9815647 • [info@lechleritalia.com](mailto:info@lechleritalia.com)

**Spain:** Lechler S.A. • Avda. Pirineos 7 • Oficina B7, Edificio Inbisa I • 28700 San Sebastián de los Reyes, Madrid • Phone: +34 91 6586346 • Fax: +34 91 6586347 • [info@lechler.es](mailto:info@lechler.es)

**Sweden:** Lechler AB • Kungsängsvägen 31 B • 753 23 Uppsala • Phone: +46 18 167030 • Fax: +46 18 167031 • [info@lechler.se](mailto:info@lechler.se)